

APPENDIX C
 CODE CHANGE PROPOSAL
 NORTH CAROLINA
 BUILDING CODE COUNCIL

B-6

325North Salisbury Street, Room 5_44
 Raleigh, North Carolina 27603
 (919) 647-0009
 carl.martin@ncdoi.gov

Granted by BCC _____ Petition for Rule Making Item Number _____
 Denied by BCC _____ Adopted by BCC _____ Approved by RRC _____
 Disapproved by BCC _____ Objection by RRC _____

PROPONENT: BCC Energy Code Ad-Hoc Committee PHONE: (919)888-0284
 REPRESENTING: BCC Energy Code Ad-Hoc Committee
 ADDRESS: Mail Service Center 1202
 CITY: Raleigh STATE: NC ZIP: 27699-1202
 E-MAIL: carl.martin@ncdoi.gov FAX: () -

North Carolina State Building Code, Volume 2024 Energy Conservation Code - Section

CHECK ONE: [] Revise section to read as follows: [] Delete section and substitute the following:
 [X] Add new section to read as follows: [] Delete section without substitution:

~~LINE THROUGH MATERIAL TO BE DELETED~~ UNDERLINE MATERIAL TO BE ADDED

Please type. Continue proposal or reason on plain paper attached to this form. See reverse side for instructions.

The 2024 NCBC is based on the 2021 IECC which can be viewed at: [Digital Codes \(iccsafe.org\)](http://digitalcodes.iccsafe.org)
 The NC amendments to the 2021 IECC that make up the 2024 NCECC are shown in ATTACHMENT A below.

Will this proposal change the cost of construction? Decrease [] Increase [] No [X]
 Will this proposal increase to the cost of a dwelling by \$80 or more? Yes [] No [X]
 Will this proposal affect the Local or State funds? Local [] State [] No [X]
 Will this proposal cause a substantial economic impact (≥\$1,000,000)? Yes [] No [X]

- Non-Substantial – Provide an economic analysis including benefit/cost estimates.
- Substantial – The economic analysis must also include 2-alternatives, time value of money and risk analysis.
- Pursuant to §143-138(a1)(2) a cost-benefit analysis is required for all proposed amendments to the NC Energy Conservation Code. The Building Code Council shall also require same for the NC Residential Code, Chapter 11.

REASON: This amendment is proposed to protect the public by updating the code to current standards of practice.

BCC CODE CHANGES

Signature: CARL MARTIN Date: November 1, 2022

FORM 11/26/19

ATTACHMENT A

THIS DOCUMENT CONTAINS PROPOSED NORTH CAROLINA AMENDMENTS TO THE 2021 EDITION OF THE INTERNATIONAL ENERGY CONSERVATION CODE (IECC) FOR THE PURPOSE OF ESTABLISHING THE 2024 EDITION OF THE NORTH CAROLINA ENERGY CONSERVATION CODE.

UNDERLINED TEXT INDICATE NORTH CAROLINA PROPOSED AMENDMENTS TO THE 2021 INTERNATIONAL IECC FOR THE 2024 NORTH CAROLINA ENERGY CONSERVATION CODE.

~~STRUCKTHROUGH~~ TEXT INDICATES IECC TEXT THAT IS PROPOSED TO BE REMOVED FROM THE 2024 NORTH CAROLINA ENERGY CONSERVATION CODE.

TEXT THAT IS HIGHLIGHTED IN **YELLOW** INDICATES PROPOSED NORTH CAROLINA AMENDMENTS THAT ARE NEW OR DIFFERENT THAN THE 2018 NORTH CAROLINA ENERGY CONSERVATION CODE.

PREFACE

Introduction

The *International Energy Conservation Code*® (IECC®) establishes minimum requirements for energy-efficient buildings using prescriptive and performance-related provisions. It is founded on broad-based principles that make possible the use of new materials and new energy-efficient designs. This 2021 edition is fully compatible with all of the International Codes® (I-Codes®) published by the International Code Council® (ICC®), including the *International Building Code*® (IBC®), *International Existing Building Code*® (IEBC®), *International Fire Code*® (IFC®), *International Fuel Gas Code*® (IFGC®), *International Green Construction Code*® (IgCC®), *International Mechanical Code*® (IMC®), *International Plumbing Code*® (IPC®), *International Private Sewage Disposal Code*® (IPSDC®), *International Property Maintenance Code*® (IPMC®), *International Residential Code*® (IRC®), *International Swimming Pool and Spa Code*® (ISPSA®), *International Wildland-Urban Interface Code*® (IWUIC®), *International Zoning Code*® (IZC®) and *International Code Council Performance Code*® (ICPC®).

This code contains separate provisions for commercial buildings and for low-rise residential buildings (3 stories or less in height above grade). Each set of provisions, IECC—Commercial Provisions and IECC—Residential Provisions, is separately applied to buildings within its respective scope. Each set of provisions is to be treated separately. Each contains a Scope and Administration chapter, a Definitions chapter, a General Requirements chapter, a chapter containing energy efficiency requirements and an Existing Buildings chapter containing provisions applicable to buildings within its scope.

The I-Codes, including the IECC, are used in a variety of ways in both the public and private sectors. Most industry professionals are familiar with the I-Codes as the basis of laws and regulations in communities across the US and in other countries. However, the impact of the codes extends well beyond the regulatory arena, as they are used in a variety of nonregulatory settings, including:

- Voluntary compliance programs such as those promoting sustainability, energy efficiency and disaster resistance.
- The insurance industry, to estimate and manage risk, and as a tool in underwriting and rate decisions.
- Certification and credentialing of individuals involved in the fields of building design, construction and safety.
- Certification of building and construction-related products.
- US federal agencies, to guide construction in an array of government-owned properties.
- Facilities management.
- “Best practices” benchmarks for designers and builders, including those who are engaged in projects in jurisdictions that do not have a formal regulatory system or a governmental enforcement mechanism.
- College, university and professional school textbooks and curricula.
- Reference works related to building design and construction.

In addition to the codes themselves, the code development process brings together building professionals on a regular basis. It provides an international forum for discussion and deliberation about

building design, construction methods, safety, performance requirements, technological advances and innovative products.

Development

This 2021 edition presents the code as originally issued, with changes reflected in the 2000 through 2018 editions and further changes approved through the ICC Code Development Process through 2019. A new edition such as this is promulgated every 3 years.

This code is founded on principles intended to establish provisions consistent with the scope of an energy conservation code that adequately conserves energy; provisions that do not unnecessarily increase construction costs; provisions that do not restrict the use of new materials, products or methods of construction; and provisions that do not give preferential treatment to particular types or classes of materials, products or methods of construction.

Maintenance

The IECC is kept up to date through the review of proposed changes submitted by code enforcement officials, industry representatives, design professionals and other interested parties. Proposed changes are carefully considered through an open code development process in which all interested and affected parties may participate.

The ICC Code Development Process reflects principles of openness, transparency, balance, due process and consensus, the principles embodied in OMB Circular A-119, which governs the federal government's use of private sector standards. The ICC process is open to anyone; there is no cost to participate, and people can participate without travel cost through the ICC's cloud-based app, cdpACCESS®. A broad cross-section of interests are represented in the ICC Code Development Process. The codes, which are updated regularly, include safeguards that allow for emergency action when required for health and safety reasons.

In order to ensure that organizations with a direct and material interest in the codes have a voice in the process, the ICC has developed partnerships with key industry segments that support the ICC's important public safety mission. Some code development committee members were nominated by the following industry partners and approved by the ICC Board:

- National Association of Home Builders (NAHB)
- National Multifamily Housing Council (NMHC)

The code development committees evaluate and make recommendations regarding proposed changes to the codes. Their recommendations are then subject to public comment and council-wide votes. The ICC's governmental members—public safety officials who have no financial or business interest in the outcome—cast the final votes on proposed changes.

The contents of this work are subject to change through the code development cycles and by any governmental entity that enacts the code into law. For more information regarding the code development process, contact the Codes and Standards Development Department of the ICC.

While the ICC Code development procedure is thorough and comprehensive, the ICC, its members and those participating in the development of the codes disclaim any liability resulting from the

publication or use of the I Codes, or from compliance or noncompliance with their provisions. The ICC does not have the power or authority to police or enforce compliance with the contents of this code.

Code Development Committee Responsibilities (Letter Designations in Front of Section Numbers)

In each code development cycle, proposed changes to this code are considered at the Committee Action Hearings by the applicable International Code Development Committee. The IECC—Commercial Provisions (sections designated with a “C” prior to the section number) are primarily maintained by the Commercial Energy Code Development Committee. The IECC—Residential Provisions (sections designated with an “R” prior to the section number) are maintained by the Residential Energy Code Development Committee. This is designated in the chapter headings by a [CE] and [RE], respectively.

Maintenance responsibilities for the IECC are designated as follows:

[CE] = International Commercial Energy Conservation Code Development Committee

[RE] = International Residential Energy Conservation Code Development Committee

For the development of the 2024 edition of the I Codes, there will be two groups of code development committees and they will meet in separate years, as shown in the following Code Development Hearings Table.

Code change proposals submitted for code sections that have a letter designation in front of them will be heard by the respective committee responsible for such code sections. Because different committees hold Committee Action Hearings in different years, proposals for several I Codes will be heard by committees in both the 2021 (Group A) and the 2022 (Group B) code development cycles.

All code change proposals for the IECC are considered in the Group B hearings.

It is very important that anyone submitting code change proposals understands which code development committee is responsible for the section of the code that is the subject of the code change proposal. For further information on the Code Development Committee responsibilities, please visit the ICC website at www.iccsafe.org/current-code-development-cycle.

CODE DEVELOPMENT HEARINGS

Group A Codes (Heard in 2021, Code Change Proposals Deadline: January 11, 2021)	Group B Codes (Heard in 2022, Code Change Proposals Deadline: January 10, 2022)
International Building Code — Egress (Chapters 10, 11, Appendix E) — Fire Safety (Chapters 7, 8, 9, 14, 26) — General (Chapters 2–6, 12, 27–33, Appendices A, B, C, D, K, N)	Administrative Provisions (Chapter 1 of all codes except IECC, IRC and IgCC; IBC Appendix O; the appendices titled “Board of Appeals” for all codes except IECC, IRC, IgCC, ICCPC and IZC; administrative updates to currently referenced standards; and designated definitions)

International Fire Code	International Building Code — Structural (Chapters 15–25, Appendices F, G, H, I, J, L, M)
International Fuel Gas Code	International Existing Building Code
International Mechanical Code	International Energy Conservation Code—Commercial
International Plumbing Code	International Energy Conservation Code—Residential — IECC—Residential — IRC—Energy (Chapter 11)
International Property Maintenance Code	International Green Construction Code — (Chapter 1)
International Private Sewage Disposal Code	International Residential Code — IRC—Building (Chapters 1–10, Appendices AE, AF, AH, AJ, AK, AL, AM, AO, AQ, AR, AS, AT, AU, AV, AW)
International Residential Code — IRC—Mechanical (Chapters 12–23) — IRC—Plumbing (Chapters 25–33, Appendices AG, AI, AN, AP)	
International Swimming Pool and Spa Code	
International Wildland Urban Interface Code	
International Zoning Code	

Note: Proposed changes to the ICCPC will be heard by the code development committee noted in brackets [] in the text of the ICCPC.

Adoption

The ICC maintains a copyright in all of its codes and standards. Maintaining copyright allows the ICC to fund its mission through sales of books, in both print and electronic formats. The ICC welcomes adoption of its codes by jurisdictions that recognize and acknowledge the ICC’s copyright in the code, and further acknowledge the substantial shared value of the public/private partnership for code development between jurisdictions and the ICC.

The ICC also recognizes the need for jurisdictions to make laws available to the public. All I-Codes and I-Standards, along with the laws of many jurisdictions, are available for free in a nondownloadable form on the ICC’s website. Jurisdictions should contact the ICC at adoptions@iccsafe.org to learn how to adopt and distribute laws based on the IECC in a manner that provides necessary access, while maintaining the ICC’s copyright.

To facilitate adoption, two sections of this code contain blanks for fill-in information that needs to be supplied by the adopting jurisdiction as part of the adoption legislation. For this code, please see:

Section C101.1. Insert: ~~[NAME OF JURISDICTION]~~.

Section R101.1. Insert: ~~[NAME OF JURISDICTION]~~.

Effective Use of the International Energy Conservation Code

The IECC is a model code that regulates minimum energy conservation requirements for new buildings. The IECC addresses energy conservation requirements for all aspects of energy use in both commercial and residential construction, including heating and ventilating, lighting, water heating, and power usage for appliances and building systems.

The IECC is a design document. For example, before one constructs a building, the designer must determine the minimum insulation R -values and fenestration U -factors for the building exterior envelope. Depending on whether the building is for residential use or for commercial use, the IECC sets forth minimum requirements for exterior envelope insulation, window and door U -factors and SHGC ratings, duct insulation, lighting and power efficiency, and water distribution insulation.

CHAPTER 1 [CE]

SCOPE AND ADMINISTRATION

User note:

— **About this chapter:** Chapter 1 establishes the limits of applicability of the code and describes how the code is to be applied and enforced. Chapter 1 is in two parts: Part 1—Scope and Application and Part 2—Administration and Enforcement. Section C101 identifies what buildings, systems, appliances and equipment fall under its purview and references other I-Codes as applicable. Standards and codes are scoped to the extent referenced.

— The code is intended to be adopted as a legally enforceable document and it cannot be effective without adequate provisions for its administration and enforcement. The provisions of Chapter 1 establish the authority and duties of the code official appointed by the authority having jurisdiction and also establish the rights and privileges of the design professional, contractor and property owner.

PART 1—SCOPE AND APPLICATION

SECTION C101 SCOPE AND GENERAL REQUIREMENTS

C101.1 Title. This code shall be known as the *Energy Conservation Code* of [NAME OF JURISDICTION NORTH CAROLINA], and shall be cited as such. It is referred to herein as “this code.”

C101.6 Requirements of other State agencies, occupational licensing board or commissions. -see the NC Administrative Code and Policies

SECTION C104 FEES

Deleted

~~**C104.1 Fees.** A permit shall not be issued until the fees prescribed in Section C104.2 have been paid, nor shall an amendment to a permit be released until the additional fee, if any, has been paid.~~

~~**C104.2 Schedule of permit fees.** A fee for each permit shall be paid as required, in accordance with the schedule as established by the applicable governing authority.~~

~~**C104.3 Work commencing before permit issuance.** Any person who commences any work before obtaining the necessary permits shall be subject to an additional fee established by the *code official* that shall be in addition to the required permit fees.~~

~~**C104.4 Related fees.** The payment of the fee for the construction, *alteration*, removal or demolition of work done in connection to or concurrently with the work or activity authorized by a permit shall not relieve the applicant or holder of the permit from the payment of other fees that are prescribed by law.~~

~~**C104.5 Refunds.** The *code official* is authorized to establish a refund policy.~~

**SECTION C105
INSPECTIONS**

**SECTION C106
NOTICE OF APPROVAL**

**SECTION C107
VALIDITY**

**SECTION C108
REFERENCED STANDARDS**

**SECTION C109
STOP WORK ORDER**

**SECTION C110
BOARD OF APPEALS**

CHAPTER 2 [CE] DEFINITIONS

User note:

— **About this chapter:** Codes, by their very nature, are technical documents. Every word, term and punctuation mark can add to or change the meaning of a technical requirement. It is necessary to maintain a consensus on the specific meaning of each term contained in the code. Chapter 2 performs this function by stating clearly what specific terms mean for the purposes of the code.

SECTION C201 GENERAL

SECTION C202 GENERAL DEFINITIONS

CHAPTER 3 [CE] GENERAL REQUIREMENTS

User note:

— **About this chapter:** Chapter 3 addresses broadly applicable requirements that would not be at home in other chapters having more specific coverage of subject matter. This chapter establishes climate zone by US counties and territories and includes methodology for determining climate zones elsewhere. It also contains product rating, marking and installation requirements for materials such as insulation, windows, doors and siding.

SECTION C301 CLIMATE ZONES

Note to ICC Editor: All states and provinces to be deleted except for NC Counties

TABLE C301.1

NORTH CAROLINA CLIMATE ZONES, MOISTURE REGIMES, AND WARM-HUMID DESIGNATIONS BY COUNTY
CLIMATE ZONES, MOISTURE REGIMES, AND WARM HUMID DESIGNATIONS BY STATE, COUNTY AND TERRITORY^a

a. Key: A – Moist, B – Dry, C – Marine. Absence of moisture designation indicates moisture regime is irrelevant. Asterisk (*) indicates a Warm Humid location.

NORTH CAROLINA
3A Alamance
3A Alexander
5A Alleghany
3A Anson
5A Ashe
5A Avery
3A Beaufort
3A Bertie
3A Bladen

3A Brunswick*
4A Buncombe
4A Burke
3A Cabarrus
4A Caldwell
3A Camden
3A Carteret*
3A Caswell
3A Catawba
3A Chatham
3A Cherokee
3A Chowan
3A Clay
3A Cleveland
3A Columbus*
3A Craven
3A Cumberland
3A Currituck
3A Dare
3A Davidson
3A Davie
3A Duplin
3A Durham
3A Edgecombe
3A Forsyth
3A Franklin
3A Gaston
3A Gates
4A Graham
3A Granville
3A Greene
3A Guilford
3A Halifax
US STATES—continued

NORTH CAROLINA *(continued)*

3A Harnett
4A Haywood
4A Henderson
3A Hertford
3A Hoke
3A Hyde
3A Iredell
4A Jackson
3A Johnston
3A Jones
3A Lee
3A Lenoir
3A Lincoln
4A Macon
4A Madison
3A Martin
4A McDowell
3A Mecklenburg
4A Mitchell
3A Montgomery
3A Moore
3A Nash
3A New Hanover*
3A Northampton
3A Onslow*
3A Orange
3A Pamlico
3A Pasquotank
3A Pender*
3A Perquimans
3A Person
3A Pitt
3A Polk
3A Randolph

3A Richmond
3A Robeson
3A Rockingham
3A Rowan
3A Rutherford
3A Sampson
3A Scotland
3A Stanly
4A Stokes
4A Surry
4A Swain
4A Transylvania
3A Tyrrell
3A Union
3A Vance
3A Wake
3A Warren
3A Washington
5A Watauga
3A Wayne
3A <u>4A</u> Wilkes
3A Wilson
4A Yadkin
5A Yancey

C301.4 Tropical climate region. ~~The tropical climate region shall be defined as:~~ Deleted.

- ~~1. Hawaii, Puerto Rico, Guam, American Samoa, US Virgin Islands, Commonwealth of Northern Mariana Islands; and~~
- ~~2. Islands in the area between the Tropic of Cancer and the Tropic of Capricorn.~~

**SECTION C302
DESIGN CONDITIONS**

**SECTION C303
MATERIALS, SYSTEMS AND EQUIPMENT**

CHAPTER 4 [CE]

COMMERCIAL ENERGY EFFICIENCY

User note:

~~— **About this chapter:** Chapter 4 presents the paths and options for compliance with the energy efficiency provisions. Chapter 4 contains energy efficiency provisions for the building envelope, mechanical and water heating systems, lighting and additional efficiency requirements. A performance alternative is also provided to allow for energy code compliance other than by the prescriptive method.~~

SECTION C401 GENERAL

C401.2.2 ASHRAE 90.1. Commercial buildings shall comply with the requirements of ANSI/ASHRAE/IESNA 90.1- and approved addenda.

SECTION C402 BUILDING ENVELOPE REQUIREMENTS

C402.1.1 Low-energy buildings and, greenhouses, and equipment buildings. The following ~~low-energy~~ buildings, or portions thereof separated from the remainder of the building by *building thermal envelope* assemblies complying with this section, shall be exempt from the *building thermal envelope* provisions of Section C402.

1. Those with a peak design rate of energy usage less than 3.4 Btu/h × ft² (10.7 W/m²) or 1.0 watt per square foot (10.7 W/m²) of floor area for space conditioning purposes.
2. Those that do not contain *conditioned space*.

~~C402.1.2~~ **C402.1.1.2 Equipment buildings.** Buildings that comply with the following shall be exempt from the *building thermal envelope* provisions of this code:

1. Are separate buildings with floor area not more than 1,200 square feet (110 m²).
2. Are intended to house electric equipment with installed equipment power totaling not less than 7 watts per square foot (75 W/m²) and not intended for human occupancy.
3. Have a heating system capacity not greater than (17,000 Btu/hr) (5 kW) and a heating thermostat setpoint that is F restricted to not more than 50°F (10°C).
4. Have an average wall and roof *U*-factor less than 0.200 in *Climate Zones* 3 through 5, ~~and less than 0.120 in *Climate Zones* 6 through 8.~~
5. Comply with the roof solar reflectance and thermal emittance provisions for *Climate Zone* 4, ~~3.~~

~~C402.5.5~~ **C402.1.2 Rooms containing fuel-burning appliances.** In *Climate Zones* 3 through 8, ~~5,~~ where combustion air is supplied through openings in an exterior wall to a room or space containing a space-conditioning fuel-burner appliance, one of the following shall apply:

1. The room or space containing the appliance shall be located outside of the *building thermal envelope*.
2. The room or space containing the appliance shall be enclosed and isolated from conditioned spaces inside the *building thermal envelope*. Such rooms shall comply with all of the following:
 - 2.1 The walls, floors and ceilings that separate the enclosed room or space from conditioned spaces shall be insulated to be not less than equivalent to the insulation requirement of below-grade walls as specified in Table C402.1.3 or Table C402.1.4.

- 2.2 The walls, floors and ceilings that separate the enclosed room or space from conditioned spaces shall be sealed in accordance with Section C402.5.1.1 C402.5.1.2.
- 2.3 The doors into the enclosed room or space shall be fully gasketed.
- 2.4 Piping serving as part of a heating or cooling system and ducts in the enclosed room or space shall be insulated in accordance with Section C403. Service water piping shall be insulated in accordance with Section C404.
- 2.5 Where an air duct supplying combustion air to the enclosed room or space passes through conditioned space, the duct shall be insulated to an R-value of not less than R-8.

TABLE C402.1.4
OPAQUE THERMAL ENVELOPE ASSEMBLY MAXIMUM REQUIREMENTS, U-FACTOR METHOD^{a, b}

CLIMATE ZONE	0 AND 1		2		3		4 EXCEPT-MARINE		5 AND MARINE 4		6		7		8	
	All other	Group R	All other	Group R	All other	Group R	All other	Group R	All other	Group R	All other	Group R	All other	Group R	All other	Group R
Roofs																
Insulation entirely above roof deck	U-0.048	U-0.039	U-0.039	U-0.039	U-0.039	U-0.039	U-0.032	U-0.032	U-0.032	U-0.032	U-0.032	U-0.032	U-0.028	U-0.028	U-0.028	U-0.028
Metal buildings	U-0.035	U-0.035	U-0.035	U-0.035	U-0.035	U-0.035	U-0.035	U-0.035	U-0.035	U-0.035	U-0.031	U-0.029	U-0.029	U-0.029	U-0.026	U-0.026
Attic and other	U-0.027	U-0.027	U-0.027	U-0.027	U-0.027	U-0.027	U-0.021	U-0.021	U-0.021	U-0.021	U-0.021	U-0.021	U-0.017	U-0.017	U-0.017	U-0.017
Walls, above grade																
Mass ^e	U-0.151	U-0.151	U-0.151	U-0.123	U-0.123	U-0.104	U-0.104	U-0.090	U-0.090	U-0.080 U-0.071	U-0.080	U-0.071	U-0.071	U-0.071	U-0.037	U-0.037
Metal building	U-0.079	U-0.079	U-0.079	U-0.079	U-0.079	U-0.052	U-0.052	U-0.050	U-0.050	U-0.050	U-0.050	U-0.050	U-0.044	U-0.039	U-0.039	U-0.039
Metal framed	U-0.077	U-0.077	U-0.077	U-0.064	U-0.064	U-0.064	U-0.064	U-0.064	U-0.055	U-0.055	U-0.049	U-0.049	U-0.049	U-0.042	U-0.037	U-0.037
Wood framed and other ^e	U-0.064	U-0.064	U-0.064	U-0.064	U-0.064	U-0.064	U-0.064	U-0.064	U-0.051	U-0.051	U-0.051	U-0.051	U-0.051	U-0.051	U-0.032	U-0.032
Walls, below grade																
Below-grade wall ^c	C-1.140 ^e	C-1.140 ^e	C-1.140 ^e	C-1.140 ^e	C-1.140 ^e	C-1.140 ^e	C-0.119	C-0.092	C-0.119	C-0.092	C-0.092	C-0.063	C-0.063	C-0.063	C-0.063	C-0.063
Floors																
Mass ^d	U-0.322 ^e	U-0.322 ^e	U-0.107	U-0.087	U-0.074 U-0.064	U-0.074 U-0.064	U-0.057	U-0.051	U-0.057	U-0.051	U-0.051	U-0.051	U-0.042	U-0.042	U-0.038	U-0.038
Joist/framing	U-0.066 ^e	U-0.066 ^e	U-0.033	U-0.033	U-0.033 U-0.032	U-0.033 U-0.032	U-0.033	U-0.033	U-0.033	U-0.033	U-0.033	U-0.027	U-0.027	U-0.027	U-0.027	U-0.027
Slab-on-grade floors																
Unheated slabs	F-0.73 ^e	F-0.73 ^e	F-0.73 ^e	F-0.73 ^e	F-0.73 ^e	F-0.54	F-0.52	F-0.52	F-0.52	F-0.51	F-0.51	F-0.434	F-0.51	F-0.434	F-0.434	F-0.424
Heated slabs ^f	F-0.69	F-0.69	F-0.69	F-0.69	F-0.66	F-0.66	F-0.62	F-0.62	F-0.62	F-0.62	F-0.62	F-0.602	F-0.602	F-0.602	F-0.602	F-0.602
Opaque doors																
Nonswinging door	U-0.31	U-0.31	U-0.31	U-0.31	U-0.31	U-0.31	U-0.31	U-0.31	U-0.31	U-0.31	U-0.31	U-0.31	U-0.31	U-0.31	U-0.31	U-0.31
Swinging door ^h	U-0.37	U-0.37	U-0.37	U-0.37	U-0.37	U-0.37	U-0.37	U-0.37	U-0.37	U-0.37	U-0.37	U-0.37	U-0.37	U-0.37	U-0.37	U-0.37

Garage door < 14% glazing ⁱ	U-0.31	U-0.31	U-0.31	U-0.31	U-0.31	U-0.31	U-0.31	U-0.31	U-0.31	U-0.31	U-0.31	U-0.31	U-0.31	U-0.31	U-0.31	U-0.31
--	--------	--------	--------	--------	--------	--------	--------	--------	--------	--------	--------	--------	--------	--------	--------	--------

c. These *C*, *F*, and *U* factors are based on assemblies that are not required to contain insulation. Not used.

TABLE C402.1.3

OPAQUE THERMAL ENVELOPE INSULATION COMPONENT MINIMUM REQUIREMENTS, R-VALUE METHOD^g

CLIMATE ZONE	0 AND 1		2		3		4 EXCEPT-MARINE		5 AND MARINE 4		6		7		8	
	All other	Group R	All other	Group R	All other	Group R	All other	Group R	All other	Group R	All other	Group R	All other	Group R	All other	Group R
Roofs																
Insulation entirely above roof deck	R-20ei	R-25ei	R-25ei	R-25ei	R-25ci	R-25ci	R-30ci	R-30ci	R-30ci	R-30ci	R-30ei	R-30ei	R-35ei	R-35ei	R-35ei	R-35ei
Metal buildings ^b	R-19+ R-11LS	R-19+ R-11LS	R-19+ R-11LS	R-19+ R-11LS	R-19+ R-11LS	R-19+ R-11LS	R-19+ R-11LS	R-19+ R-11LS	R-19+ R-11LS	R-19+ R-11LS	R-25+ R-11LS	R-30+ R-11LS	R-30+ R-11LS	R-30+ R-11LS	R-25+ R-11+ R-11LS	R-25+ R-11+ R-11LS
Attic and other	R-38	R-38	R-38	R-38	R-38	R-38	R-49	R-49	R-49	R-49	R-49	R-49	R-60	R-60	R-60	R-60
Walls, above grade																
Mass ^f	R-5.7ei*	R-5.7ei*	R-5.7ei*	R-7.6ei	R-7.6ci	R-9.5ci	R-9.5ci	R-11.4ci	R-11.4ci	R-13.3ei R-15ci	R-13.3ei	R-15.2ei	R-15.2ei	R-15.2ei	R-25ei	R-25ei
Metal building	R-13+ R-6.5ei	R-13+ R-6.5ei	R-13+ R-6.5ei	R-13+ R-13ei	R-13+ R-6.5ci	R-13+ R-13ci	R-13+ R-13ci	R-13+ R-14ci	R-13+ R-14ci	R-13+ R-14ci	R-13+ R-14ei	R-13+ R-14ei	R-13+ R-17ei	R-13+ R-19.5ei	R-13+ R-19.5ei	R-13+ R-19.5ei
Metal framed	R-13+ R-5ei	R-13+ R-5ei	R-13+ R-5ei	R-13+ R-7.5ei	R-13+ R-7.5ci	R-13+ R-7.5ci	R-13+ R-7.5ci	R-13+ R-7.5ci	R-13+ R-10ci	R-13+ R-10ci	R-13+ R-12.5ei	R-13+ R-12.5ei	R-13+ R-12.5ei	R-13+ R-15.6ei	R-13+ R-18.8ei	R-13+ R-18.8ei
Wood framed and other	R-13+ R-3.8ei or R-20	R-13+ R-3.8ei or R-20	R-13+ R-3.8ei or R-20	R-13+ R-3.8ei or R-20	R-13+ R-3.8ci or R-20	R-13+ R-3.8ci or R-20	R-13+ R-3.8ci or R-20	R-13+ R-3.8ci or R-20	R-13+ R-7.5ci or R-20 + R-3.8ci	R-13+ R-7.5ci or R-20 + R-3.8ci	R-13+ R-7.5ei or R-20 + R-3.8ei	R-13+ R-7.5ei or R-20 + R-3.8ei	R-13+ R-7.5ei or R-20 + R-3.8ei	R-13+ R-7.5ei or R-20 + R-3.8ei	R-13+ R-18.8ei	R-13+ R-18.8ei
Walls, below grade																
Below-grade wall ^d	NR	NR	NR	NR	NR R-7.5ci	NR R-7.5ci	R-7.5ci	R-10ci	R-7.5ci	R-10ci	R-10ei	R-15ei	R-15ei	R-15ei	R-15ei	R-15ei
Floors																
Mass ^e	NR	NR	R-6.3ei	R-8.3ei	R-10ei R-12.5ci	R-10ei R-12.5ci	R-14.6ci	R-16.7ci	R-14.6ci	R-16.7ci	R-16.7ei	R-16.7ei	R-20.9ei	R-20.9ei	R-23ei	R-23ei
Joist/framing	R-13	R-13	R-30	R-30	R-30 ^e	R-30 ^e	R-30 R-38	R-30 R-38	R-30 R-38	R-30 R-38	R-38	R-38	R-38	R-38	R-38	R-38
Slab-on-grade floors																
Unheated slabs	NR	NR	NR	NR	NR	R-10 for 24" below	R-15 for 24" below	R-15 for 24" below	R-15 for 24" below	R-20 for 24" below	R-20 for 24" below	R-20 for 24" below	R-20 for 48" below	R-20 for 48" below	R-20 for 48" below	R-25 for 48" below ●
Heated slabs ^g	R-7.5 for- 12" below+ R-5 full- slab	R-7.5 for- 12" below+ R-5 full- slab	R-7.5 for- 12" below+ R-5 full- slab	R-7.5 for- 12" below+ R-5 full- slab	R-10 for 24" below+ R-5 full slab	R-10 for 24" below+ R-5 full slab	R-15 for 24" below+ R-5 full slab	R-15 for 24" below+ R-5 full slab	R-15 for 36" below+ R-5 full slab	R-15 for 36" below+ R-5 full slab	R-15 for 36" below+ R-5 full- slab	R-20 for 48" below+ R-5 full- slab	R-20 for 48" below+ R-5 full- slab	R-20 for 48" below+ R-5 full- slab	R-20 for 48" below+ R-5 full- slab	R-20 for 48" below+ R-5 full- slab

c. R-5.7ei is allowed to be substituted with concrete block walls complying with ASTM C90, ungrouted or partially grouted at 32 inches or less on center vertically and 48 inches or less on center horizontally, with ungrouted cores filled with materials having a maximum thermal conductivity of 0.44 Btu-in/h-ft²-°F. Steel floor joist systems shall be insulated to R-38.

**TABLE C402.4
BUILDING ENVELOPE FENESTRATION MAXIMUM U-FACTOR AND SHGC^a REQUIREMENTS**

CLIMATE ZONE	0 AND 1	2	3	4 EXCEPT MARINE	5 AND MARINE 4	6	7	8								
Vertical fenestration																
<i>U</i> -factor																
Fixed fenestration	0.50	0.45	0.42	0.36	0.36	0.34	0.29	0.26								
Operable fenestration	0.62	0.60	0.54	0.45	0.45	0.42	0.36	0.32								
Entrance doors	0.83	0.77	0.68	0.63	0.63	0.63	0.63	0.63								
SHGC																
	Fixed	Operable	Fixed	Operable	Fixed	Operable	Fixed	Operable	Fixed	Operable	Fixed	Operable	Fixed	Operable	Fixed	Operable
PF < 0.2	0.23	0.21	0.25	0.23	0.25	0.23	0.36	0.33	0.38	0.33	0.38	0.34	0.40	0.36	0.40	0.36
0.2 ≤ PF < 0.5	0.28	0.25	0.30	0.28	0.30	0.28	0.43	0.40	0.46	0.40	0.46	0.41	0.48	0.43	0.48	0.43
PF ≥ 0.5	0.37	0.34	0.40	0.37	0.40	0.37	0.58	0.53	0.61	0.53	0.61	0.54	0.64	0.58	0.64	0.58
Fixed fenestration					0.25		0.36		0.38							
Operable fenestration					0.23		0.33		0.33							
Skylights																
<i>U</i> -factor	0.70	0.65	0.55	0.50	0.50	0.50	0.50	0.44	0.41							
SHGC	0.30	0.30	0.30	0.40	0.40	0.40	NR	NR								

NR = No Requirement, PF = Projection Factor. a. C402.4.1.3 shall apply

C402.1.5 Component performance alternative. Building envelope values and fenestration areas determined in accordance with Equation 4-2 shall be an alternative to compliance with the *U*-, *F*- and *C*-factors in Tables C402.1.4 and C402.4 and the maximum allowable fenestration areas in Section C402.4.1. A version of IECC-2021 COMcheck with NC-specific amendments shall be permitted to demonstrate compliance. Fenestration shall meet the applicable SHGC requirements of Section C402.4.3.

C402.3 Roof solar reflectance and thermal emittance. Low-sloped roofs directly above cooled conditioned spaces in *Climate Zone Zones 0 through 3* shall comply with one or more of the options in Table C402.3.

C402.4.1.1 Increased vertical fenestration area with daylight responsive controls. Deleted. In Climate Zones 0 through 6, not more than 40 percent of the gross above-grade wall area shall be vertical fenestration, provided that all of the following requirements are met:

1. In buildings not greater than two stories above grade, not less than 50 percent of the net floor area is within a *daylight zone*.
2. In buildings three or more stories above grade, not less than 25 percent of the net floor area is within a *daylight zone*.
3. *Daylight responsive controls* are installed in *daylight zones*.
4. Visible transmittance (VT) of vertical fenestration is not less than 1.1 times solar heat gain coefficient (SHGC).

Exception: Fenestration that is outside the scope of NFRC 200 is not required to comply with Item 4.

C402.4.1.2 Increased skylight area with daylight responsive controls. The skylight area shall be not more than 6 percent of the roof area provided that *daylight responsive controls* are installed in *toplit daylight zones*. Deleted.

C402.4.1.3 Maximum Area by Orientation Vertical fenestration shall comply with not less than one of the following:

1. $\text{Area}_{\text{east}} \leq 0.25 \times \text{Area}_{\text{total}}$ and $\text{Area}_{\text{west}} \leq 0.25 \times \text{Area}_{\text{total}}$
2. $\text{Area}_{\text{east}} \times \text{SHGC}_{\text{east}} \leq 0.25 \times \text{Area}_{\text{total}} \times \text{SHGC}_{\text{table}}$ and $\text{Area}_{\text{west}} \times \text{SHGC}_{\text{west}} \leq 0.25 \times \text{Area}_{\text{total}} \times \text{SHGC}_{\text{table}}$

where

$\text{Area}_{\text{east}}$ is the total vertical fenestration area oriented within 45 degrees of true east to the south and 22.5 degrees of true east to the north

$\text{Area}_{\text{west}}$ is the total vertical fenestration area oriented within 45 degrees of true west to the south and 22.5 degrees of true west to the north

$\text{Area}_{\text{total}}$ is the total vertical fenestration area of the building

$\text{SHGC}_{\text{east}}$ is the maximum Solar Heat Gain Coefficient of $\text{Area}_{\text{east}}$ of the building

$\text{SHGC}_{\text{west}}$ is the maximum Solar Heat Gain Coefficient of $\text{Area}_{\text{west}}$ of the building

$\text{SHGC}_{\text{table}}$ is the maximum Solar Heat Gain Coefficient in Table C402.4 for the building climate zone

C402.4.2 Minimum skylight fenestration area. Skylights shall be provided in enclosed spaces greater than 2,500 square feet (232 m²) in floor area, directly under a roof with not less than 75 percent of the ceiling area with a ceiling height greater than 15 feet (4572 mm), and used as an office, lobby, atrium, concourse, corridor, storage space, gymnasium/exercise center, convention center, automotive service area, space where manufacturing occurs, nonrefrigerated warehouse, retail store, distribution/sorting area, transportation depot or workshop. The total *toplit daylight zone* shall be not less than half the floor area and shall comply with one of the following:

1. A minimum skylight area to *toplit daylight zone* of not less than 3 percent where all skylights have a VT of not less than 0.40, or $\text{VT}_{\text{annual}}$ of not less than 0.26, as determined in accordance with Section C303.1.3.
2. A minimum skylight effective aperture, determined in accordance with Equation 4-4, of:
 - 2.1. Not less than 1 percent using a skylight's VT rating; or
 - 2.2. Not less than 0.66 percent using a Tubular Daylight Device's $\text{VT}_{\text{annual}}$ rating.

Skylight Effective Aperture =

$$\frac{0.85 \times \text{Skylight Area} \times \text{Skylight VT} \times \text{WF}}{\text{Toplit Zone}}$$

(Equation 4-4)

where:

Skylight area = Total fenestration area of skylights.

Skylight VT = Area weighted average visible transmittance of skylights.

WF = Area weighted average well factor, where well factor is 0.9 if light well depth is less than 2 feet (610 mm), or 0.7 if light well depth is 2 feet (610 mm) or greater, or 1.0 for Tubular Daylighting Devices with VT_{annual} ratings.

Light well depth = Measure vertically from the underside of the lowest point of the skylight glazing to the ceiling plane under the skylight.

Exception: Skylights above *daylight zones* of enclosed spaces are not required in:

1. Buildings in *Climate Zones* 6 through 8.
2. Spaces where the designed *general lighting* power densities are less than 0.5 W/ft² (5.4 W/m²).
3. Areas where it is documented that existing structures or natural objects block direct beam sunlight on not less than half of the roof over the enclosed area for more than 1,500 daytime hours per year between 8 a.m. and 4 p.m.
4. Spaces where the *daylight zone* under rooftop monitors is greater than 50 percent of the enclosed space floor area.
5. Spaces where the total area minus the area of *sidelit daylight zones* is less than 2,500 square feet (232 m²), and where the lighting is controlled in accordance with Section C405.2.3.
6. Spaces designed as storm shelters complying with ICC 500. Deleted.

C402.4.2.1 C402.4.2 Lighting controls in toplit daylight zones. *Daylight responsive controls* shall be provided in toplit daylight zones.

C402.4.3 Maximum U-factor and SHGC. The maximum *U*-factor and solar heat gain coefficient (SHGC) for fenestration shall be as specified in Table C402.4.

The window projection factor shall be determined in accordance with Equation 4-5:

$$PF = A/B \quad \text{(Equation 4-5)}$$

where:

PF = Projection factor (decimal).

A = Distance measured horizontally from the farthest continuous extremity of any overhang, eave or permanently attached shading device to the vertical surface of the glazing.

B = Distance measured vertically from the bottom of the glazing to the underside of the overhang, eave or permanently attached shading device.

Where different windows or glass doors have different *PF* values, they shall each be evaluated separately.

C402.4.3.1 Increased skylight SHGC. In *Climate Zones* 0 through 6, skylights shall be permitted a maximum SHGC of 0.60 where located above *daylight zones* provided with *daylight responsive controls*.

C402.4.3.2 Increased skylight U-factor. Where skylights are installed above *daylight zones* provided with *daylight responsive controls*, a maximum *U* factor of 0.9 shall be permitted in *Climate Zones* 0 through 3 and a maximum *U* factor of 0.75 shall be permitted in *Climate Zones* 4 through 8.

C402.4.3.3 C402.4.3.1 Dynamic glazing. Where dynamic glazing is intended to satisfy the SHGC and VT requirements of Table C402.4, the ratio of the higher to lower labeled SHGC shall be greater than or equal to 2.4, and the *dynamic glazing* shall be automatically controlled to modulate the amount of solar gain into the space in multiple steps. Dynamic glazing

shall be considered separately from other fenestration, and area-weighted averaging with other fenestration that is not dynamic glazing shall not be permitted.

Exception: Dynamic glazing is not required to comply with this section where both the lower and higher labeled SHGC already comply with the requirements of Table C402.4.

~~C402.4.3.4~~ **C402.4.3.2 Area-weighted *U*-factor.** An area-weighted average shall be permitted to satisfy the *U*-factor requirements for each fenestration product category listed in Table C402.4. Individual fenestration products from different fenestration product categories listed in Table C402.4 shall not be combined in calculating area-weighted average *U*-factor.

C402.4.4 Daylight zones. Daylight zones ~~referenced in Sections C402.4.1.1 through C402.4.3.2~~ shall comply with Sections C405.2.4.2 and C405.2.4.3, as applicable. Daylight zones shall include *toplit daylight zones* and daylight sidelit zones.

C402.5 Air leakage—building thermal envelope. ~~The building thermal envelope shall comply with Sections C402.5.1 through Section C402.5.11.1 C402.5.8.1, or the building thermal envelope shall be tested in accordance with Section C402.5.2 or C402.5.3. Where compliance is based on such testing, the building shall also comply with Sections C402.5.7, C402.5.8 and C402.5.9.~~

C402.5.1 Air barriers. A continuous *air barrier* shall be provided throughout the *building thermal envelope*. ~~The continuous air barriers shall be located on the~~ is permitted to be any combination of inside, or outside, or within the building thermal envelope, located within the assemblies composing the building thermal envelope, or any combination thereof. ~~The air barrier shall comply with Sections C402.5.1.1, and C402.5.1.2. The air leakage performance of the air barrier shall be verified in accordance with Section C402.5.2.~~

~~**Exception:** Air barriers are not required in buildings located in *Climate Zone 2B*.~~ Deleted.

C402.5.1.1 Air barrier design and documentation requirements. Design of the continuous *air barrier* shall be documented in the following manner:

1. Components comprising the continuous *air barrier* and their position within each *building thermal envelope* assembly shall be identified.
2. Joints, interconnections, and penetrations of the continuous *air barrier* components shall be detailed.
3. The continuity of the *air barrier* building element assemblies that enclose conditioned space or provide a boundary between conditioned space and unconditioned space shall be identified.
4. Documentation of the continuous air barrier shall detail methods of sealing the air barrier such as wrapping, caulking, gasketing, taping or other *approved* methods at the following locations:
 - 4.1. Joints around fenestration and door frames.
 - 4.2. Joints between walls and floors, between walls at building corners, between walls and roofs including parapets and copings, where above-grade walls meet foundations, and similar intersections.
 - 4.3. Penetrations or attachments through the continuous *air barrier* in building envelope roofs, walls, and floors.
 - 4.4. Building assemblies used as ducts or plenums.
 - 4.5. Changes in continuous *air barrier* materials and assemblies.
5. Identify where testing will or will not be performed in accordance with Section C402.5.2. Where testing will not be performed, a plan for field inspections required by C402.5.2.3 shall be provided that includes the following:
 - 5.1 Schedule for periodic inspection.
 - 5.2 Continuous air barrier scope of work.
 - 5.3 List of critical inspection items.
 - 5.4 Inspection documentation requirements, and
 - 5.5 Provisions for corrective actions where needed.

~~C402.5.1.1~~ **C402.5.1.2 Air barrier construction.** The *continuous air barrier* shall be constructed to comply with the following:

1. The ~~air barrier~~ *air barrier* shall be continuous for all assemblies that ~~are~~ comprise the building thermal envelope of ~~the building~~ and across the joints and assemblies.
2. Air barrier joints and seams shall be sealed, including sealing transitions in places and changes in materials. The joints and seals shall be securely installed in or on the joint for its entire length so as not to dislodge, loosen or otherwise impair its ability to resist positive and negative pressure from wind, stack effect and mechanical ventilation.
3. Penetrations of the ~~air barrier~~ *air barrier* shall be caulked, gasketed or otherwise sealed in a manner compatible with the construction materials and location. Sealing shall allow for expansion, contraction and mechanical vibration. ~~Joints and seams associated with penetrations shall be sealed in the same manner or taped. Sealing materials shall be securely installed around the penetration so as not to dislodge, loosen or otherwise impair the penetrations' ability to resist positive and negative pressure from wind, stack effect and mechanical ventilation. Sealing materials shall be securely installed around the penetration so as not to dislodge, loosen or otherwise impair the penetrations' ability to resist positive and negative pressure.~~ Sealing of concealed fire sprinklers, where required, shall be in a manner that is recommended by the fire sprinkler manufacturer. Caulking or other adhesive sealants shall not be used to fill voids between fire sprinkler cover plates and walls or ceilings.
4. Recessed lighting fixtures shall comply with Section ~~C402.5.10~~. C402.5.1.2.1. Where similar objects are installed that penetrate the ~~air barrier~~ *air barrier*, provisions shall be made to maintain the integrity of the ~~air barrier~~ *air barrier*.
5. Electrical and communication boxes shall comply with C402.5.1.2.2.

~~C402.5.1.2 Air barrier compliance.~~ A continuous air barrier for the opaque building envelope shall comply with the following:

1. ~~Buildings or portions of buildings, including Group R and I occupancies, shall meet the provisions of Section C402.5.2.~~

~~Exception:~~ Buildings in Climate Zones 2B, 3C and 5C. ~~Deleted.~~

2. ~~Buildings or portions of buildings other than Group R and I occupancies shall meet the provisions of Section C402.5.3.~~

~~Exceptions:~~

1. ~~Buildings in Climate Zones 2B, 3B, 3C and 5C. Deleted.~~
2. ~~Buildings larger than 5,000 square feet (464.5 m²) floor area in Climate Zones 0B, 1, 2A, 4B and 4C. Deleted.~~
3. ~~Buildings between 5,000 square feet (464.5 m²) and 50,000 square feet (4645 m²) floor area in Climate Zones 0A, Zone 3A. and 5B.~~

3. ~~Buildings or portions of buildings that do not complete air barrier testing shall meet the provisions of Section C402.5.1.3 or C402.5.1.4 in addition to Section C402.5.1.5.~~

~~C402.5.10~~ C402.5.1.2.1 Recessed lighting. Recessed luminaires installed in the *building thermal envelope* shall be all of the following:

1. IC-rated.
2. Labeled as having an air leakage rate of not ~~more~~ greater than 2.0 cfm (0.944 L/s) ~~when~~ where tested in accordance with ASTM E283 at a 1.57 psf (75 Pa) pressure differential.
3. Sealed with a gasket or caulk between the housing and interior wall or ceiling covering.

C402.5.1.2.2 Electrical and communication boxes. Electrical and communication boxes that penetrate the air barrier of the building thermal envelope, and that do not comply with C402.5.1.2.2.1, shall be caulked, taped, gasketed, or otherwise sealed

to the air barrier element being penetrated. All openings on the concealed portion of the box shall be sealed. Where present, insulation shall rest against all concealed portions of the box.

C402.5.1.2.2.1 Air-sealed boxes. Where air-sealed boxes are installed, they shall be marked in accordance with NEMA OS 4. Air-sealed boxes shall be installed in accordance with the manufacturer's instructions.

C402.5.1.3 Materials. Deleted. Refer to **C402.5.2.3.1**

C402.5.1.4 Assemblies. Deleted. Refer to **C402.5.2.3.2**

C402.5.1.5 Building envelope performance verification. The installation of the continuous air barrier shall be verified by the *code official*, a *registered design professional* or *approved* agency in accordance with the following:

1. A review of the construction documents and other supporting data shall be conducted to assess compliance with the requirements in Section C402.5.1.
2. Inspection of continuous air barrier components and assemblies shall be conducted during construction while the air barrier is still accessible for inspection and repair to verify compliance with the requirements of Sections ~~C402.5.1.3~~ **C402.5.2.3.1** and ~~C402.5.1.4~~ **C402.5.2.3.2**.
3. A final commissioning report shall be provided for inspections completed by the *registered design professional* or *approved* agency. The commissioning report shall be provided to the building owner or owner's authorized agent and the *code official*. The report shall identify deficiencies found during the review of the construction documents and inspection and details of corrective measures taken.

C402.5.2 Air leakage compliance. *Air leakage of the building thermal envelope shall be tested by an approved third party in accordance with C402.5.2.1. The measured air leakage shall not be greater than 0.35 cfm/ft² (1.8 L/s × m²) of the building thermal envelope area at a pressure differential of 0.3 inch water gauge (75 Pa) with the calculated building thermal envelope surface area being the sum of the above- and below-grade building thermal envelope.*

Exceptions:

1. Where the measured air leakage rate is greater than 0.35 cfm/ft² (1.8 L/s × m²) but is not greater than 0.45 cfm/ft² (2.3 L/s × m²), the approved third party shall perform a diagnostic evaluation using smoke tracer or infrared imaging. The evaluation shall be conducted while the building is pressurized along with a visual inspection of the air barrier in accordance with ASTM E1186. All identified leaks shall be sealed where such sealing can be made without damaging existing building components. A report specifying the corrective actions taken to seal leaks shall be deemed to establish compliance with the requirements of this section where submitted to the code official and the building owner. Where the measured air leakage rate is greater than 0.45 cfm/ft² (2.3 L/s × m²), corrective actions must be made to the building and an additional test completed for which the results are 0.45 cfm/ft² (2.3 L/s × m²), or less.
2. ~~Buildings in Climate Zones 2B.- Deleted~~
3. Buildings larger than 25,000 square feet (2300 m²) floor area in Climate Zones 0 through 3 and 4, other than Group R and I occupancies, that comply with C402.5.2.3.
4. As an alternative, buildings or portions of buildings, containing Group R and I occupancies, shall be permitted to be tested by an approved third party in accordance with C402.5.2.2. The reported air leakage of the building thermal envelope shall not be greater than 0.27 cfm/ft² (1.4 L/s × m²) of the testing unit enclosure area at a pressure differential of 0.2 inch water gauge (50 Pa), or 0.36 cfm/ft² at a pressure differential of 75Pa (0.30 in. w.g.) in accordance with pressure/leakage correlation Table C402.5.2.

Table C402.5.2 Pressure/leakage correlation Table C402.5 .2 .

Pressure Differential (Pa)	Test pressure Adjustment Factor	Max Air Leakage / Building Thermal Envelope (CFM / ft ²)		
75 (0.30 in. w.g.)		0.36	0.37	0.40
50 (0.20 in. w.g.)	0.752897957	0.27	0.28	0.30

Example: If maximum air leakage allowed is 0.27 cfm/ft² of bldg thermal envelope at 50 Pa(0.2 in w.g.), the corresponding maximum leakage rate is 0.36 cfm/SF of bldg thermal envelope if using a higher test pressure of 75 Pa(0.3 in w.g.)

C402.5.2.1 Whole building test method and reporting. The building thermal envelope shall be tested for air leakage in accordance with ASTM E3158 or an equivalent approved method. A report that includes the tested surface area, floor area, air by volume, stories above grade, and leakage rates shall be submitted to the code official and the building owner.

Exceptions:

1. For buildings less than 10,000 ft² (1000 m²) the entire building thermal envelope shall be permitted to be tested in accordance with ASTM E779, ASTM E3158 or ASTM E1827 or an equivalent approved method.
2. For buildings greater than 50,000 ft² (4645 m²), portions of the building shall be permitted to be tested and the measured air leakage shall be area-weighted by the surface areas of the building thermal envelope in each portion. The weighted average tested air leakage shall not be greater than the whole building leakage limit. The following portions of the building shall be tested:
 1. The entire building thermal envelope area of stories that have any conditioned spaces directly under a roof.
 2. The entire building thermal envelope area of stories that have a building entrance, a floor over unconditioned space, a loading dock, or that are below grade.
 3. Representative above-grade portions of the building totaling not less than 25 percent of the wall area enclosing the remaining conditioned space.

C402.5.2.2 Dwelling and sleeping unit enclosure test method and reporting. The building thermal envelope shall be tested for air leakage in accordance with ASTM E779, ANSI/RESNET/ICC 380, ASTM E1827 or an equivalent approved method. Where multiple dwelling units or sleeping units or other enclosed spaces are contained within one building thermal envelope, each shall be considered an individual testing unit, and the building air leakage shall be the weighted average of all tested unit results, weighted by each testing unit enclosure area. Units shall be tested without simultaneously pressuring adjacent units and shall be separately tested as follows:

1. Where buildings have less than eight total dwelling or sleeping testing units, each testing unit shall be tested.
2. Where buildings have eight or more testing units, the greater of seven units or 20 percent of the testing units in the building shall be tested, including a top floor unit, a middle floor unit, a ground floor unit and a unit with the largest testing unit enclosure area. For each tested unit that exceeds the maximum air leakage rate, an additional three units shall be tested, including a mixture of unit types and locations.

~~3. Enclosed spaces with not less than one exterior wall in the building thermal envelope shall be tested in accordance with C402.5.3.~~

~~Exception: Corridors, stairwells, and enclosed spaces having a conditioned floor area not greater than 1,500 ft² shall be permitted to comply with Section C402.5.1.5 and either Section C402.5.1.3 C402.5.2.3.1 or C402.5.1.4. C402.5.2.3.2~~

C402.5.2.3 Building envelope design and construction verification criteria. Where Sections C402.5.2.1 and C402.5.2.2 are not applicable, the installation of the continuous air barrier shall be verified by the code official, a registered design professional or approved agency in accordance with the following:

1. A review of the construction documents and other supporting data shall be conducted to assess compliance with the requirements in Section C402.5.1.

2. Inspection of continuous *air barrier* components and assemblies shall be conducted during construction to verify compliance with the requirements of Sections C402.5.2.3.1 or C402.5.2.3.2. The *air barrier* shall remain accessible for inspection and repair.
3. A final inspection report shall be provided for inspections completed by the *registered design professional* or *approved agency*. The inspection report shall be provided to the building owner or owner's authorized agent and the *code official*. The report shall identify deficiencies found during inspection and details of corrective measures taken.

C402.5.2 Dwelling and sleeping unit enclosure testing. ~~The *building thermal envelope* shall be tested in accordance with ASTM E779, ANSI/RESNET/ICC 380, ASTM E1827 or an equivalent method approved by the *code official*. The measured air leakage shall not exceed 0.30 cfm/ft² (1.5 L/s × m²) of the testing unit enclosure area at a pressure differential of 0.2 inch water gauge (50 Pa). Where multiple dwelling units or sleeping units or other occupiable conditioned spaces are contained within one *building thermal envelope*, each unit shall be considered an individual testing unit, and the building air leakage shall be the weighted average of all testing unit results, weighted by each testing unit's enclosure area. Units shall be tested separately with an unguarded blower door test as follows:~~

1. ~~Where buildings have fewer than eight testing units, each testing unit shall be tested.~~
2. ~~For buildings with eight or more testing units, the greater of seven units or 20 percent of the testing units in the building shall be tested, including a top floor unit, a ground floor unit and a unit with the largest testing unit enclosure area. For each tested unit that exceeds the maximum air leakage rate, an additional two units shall be tested, including a mixture of testing unit types and locations.~~

C402.5.3 Building thermal envelope testing. ~~The *building thermal envelope* shall be tested in accordance with ASTM E779, ANSI/RESNET/ICC 380, ASTM E3158 or ASTM E1827 or an equivalent method approved by the *code official*. The measured air leakage shall not exceed 0.40 cfm/ft² (2.0 L/s × m²) of the *building thermal envelope* area at a pressure differential of 0.3 inch water gauge (75 Pa). Alternatively, portions of the building shall be tested and the measured air leakages shall be area-weighted by the surface areas of the building envelope in each portion. The weighted average test results shall not exceed the whole building leakage limit. In the alternative approach, the following portions of the building shall be tested:~~

1. ~~The entire envelope area of all stories that have any spaces directly under a roof.~~
2. ~~The entire envelope area of all stories that have a building entrance, exposed floor, or loading dock, or are below grade.~~
3. ~~Representative above grade sections of the building totaling at least 25 percent of the wall area enclosing the remaining conditioned space.~~

Exception: ~~Where the measured air leakage rate exceeds 0.40 cfm/ft² (2.0 L/s × m²) but does not exceed 0.60 cfm/ft² (3.0 L/s × m²), a diagnostic evaluation using smoke tracer or infrared imaging shall be conducted while the building is pressurized along with a visual inspection of the air barrier. Any leaks noted shall be sealed where such sealing can be made without destruction of existing building components. An additional report identifying the corrective actions taken to seal leaks shall be submitted to the *code official* and the building owner, and shall be deemed to comply with the requirements of this section.~~

~~C402.5.1.3~~ **C402.5.2.3.1 Materials.** Materials with an air permeability not greater than 0.004 cfm/ft² (0.02 L/s × m²) under a pressure differential of 0.3 inch water gauge (75 Pa) when tested in accordance with ASTM E2178 shall comply with this section. Materials in Items 1 through 16 shall be deemed to comply with this section, provided that joints are sealed and materials are installed as air barriers in accordance with the manufacturer's instructions.

1. Plywood with a thickness of not less than ³/₈ inch (10 mm).
2. Oriented strand board having a thickness of not less than ³/₈ inch (10 mm).
3. Extruded polystyrene insulation board having a thickness of not less than ¹/₂ inch (12.7 mm).
4. Foil-back polyisocyanurate insulation board having a thickness of not less than ¹/₂ inch (12.7 mm).

5. Closed-cell spray foam having a minimum density of 1.5 pcf (2.4 kg/m³) and having a thickness of not less than 1½ inches (38 mm).
6. Open-cell spray foam with a density between 0.4 and 1.5 pcf (0.6 and 2.4 kg/m³) and having a thickness of not less than 4.5 inches (113 mm).
7. Exterior or interior gypsum board having a thickness of not less than ½inch (12.7 mm).
8. Cement board having a thickness of not less than ½inch (12.7 mm).
9. Built-up roofing membrane.
10. Modified bituminous roof membrane.
11. Single-ply roof membrane.
12. A Portland cement/sand parge, or gypsum plaster having a thickness of not less than ⅝ inch (15.9 mm).
13. Cast-in-place and precast concrete.
14. Fully grouted concrete block masonry.
15. Sheet steel or aluminum.
16. Solid or hollow masonry constructed of clay or shale masonry units.

~~C402.5.1.4~~ ~~C402.5.2.3.2~~ Assemblies. Assemblies of materials and components with an average air leakage not greater than 0.04 cfm/ft² (0.2 L/s × m²) under a pressure differential of 0.3 inch of water gauge (w.g.)(75 Pa) when tested in accordance with ASTM E2357, ASTM E1677, ASTM D8052 or ASTM E283 shall comply with this section. Assemblies listed in Items 1 through 3 shall be deemed to comply, provided that joints are sealed and the requirements of Section C402.5.1.1 are met.

1. Concrete masonry walls coated with either one application of block filler or two applications of a paint or sealer coating.
2. Masonry walls constructed of clay or shale masonry units with a nominal width ~~of greater than or equal to~~ 4 inches (102 mm) ~~or more.~~
3. A Portland cement/sand parge, stucco or plaster not less than ½inch (12.7 mm) in thickness.

~~C402.5.4~~ ~~C402.5.3~~ Air leakage of fenestration. The air leakage of fenestration assemblies shall ~~meet~~ comply with the provisions of Table C402.5.4. C402.5.3. Testing shall be in accordance with the applicable reference test standard in Table C402.5.4 by an accredited, independent testing laboratory and labeled by the manufacturer. Testing shall be conducted by an accredited, independent testing laboratory in accordance with the applicable reference test standard in Table C402.5.3 and labeled by the manufacturer.

Exceptions:

1. Field-fabricated fenestration assemblies that are sealed in accordance with Section ~~C402.5.1. C402.5.1.2.~~
2. ~~Fenestration in buildings that comply with the testing alternative of Section C402.5 are not required to meet the air leakage requirements in Table C402.5.4. Fenestration in buildings that are tested for air leakage of in accordance with Section C402.5.2 are not required to meet the air leakage requirements in Table C402.5.3.~~

~~C402.5.5 Rooms containing fuel-burning appliances.~~ Moved to Section C402.1.2

~~C402.5.6~~ ~~C402.5.4~~ Doors and access openings to shafts, chutes, stairways and elevator lobbies. Doors and *access* openings from conditioned space to shafts, chutes stairways and elevator lobbies not within the scope of the fenestration assemblies covered by Section ~~C402.5.4~~ C402.5.3 shall be gasketed, weather-stripped or sealed.

Exceptions:

1. Door openings required to comply with Section 716 of the *International Building Code*.
2. Doors and door openings required to comply with UL 1784 by the *International Building Code*.

~~C402.5.7~~ **C402.5.5 Air intakes, exhaust openings, stairways and shafts.** Stairway enclosures, elevator shaft vents and other outdoor air intakes and exhaust openings integral to the building envelope shall be provided with dampers in accordance with Section C403.7.7.

~~C402.5.8~~ **Loading dock weather seals.** Cargo door openings and loading door openings shall be equipped with weather seals that restrict infiltration and provide direct contact along the top and sides of vehicles that are parked in the doorway.

~~C402.5.9~~ **C402.5.6 Vestibules.** Building entrances shall be protected with an enclosed vestibule, with all doors opening into and out of the vestibule equipped with self-closing devices. Vestibules shall be designed so that in passing through the vestibule it is not necessary for the interior and exterior doors to open at the same time. The installation of one or more revolving doors in the *building entrance* shall not eliminate the requirement that a vestibule be provided on any doors adjacent to revolving doors.

Exceptions: Vestibules are not required for the following:

1. ~~Buildings in Climate Zones 0 through 2. Deleted.~~
2. Doors not intended to be used by the public, such as doors to mechanical or electrical equipment rooms, or intended solely for employee use.
3. Doors opening directly from a *sleeping unit* or dwelling unit.
4. Doors that open directly from a space less than 3,000 square feet (298 m²) in area.
5. Revolving doors.
6. Doors used primarily to facilitate vehicular movement or material handling and adjacent personnel doors.
7. Doors that have an air curtain with a velocity of not less than 6.56 feet per second (2 m/s) at the floor that have been tested in accordance with ANSI/AMCA 220 and installed in accordance with the manufacturer's instructions. Manual or automatic controls shall be provided that will operate the air curtain with the opening and closing of the door. Air curtains and their controls shall comply with Section C408.2.3.

~~C402.5.8~~ ~~C402.5.7~~ **Loading dock weather seals.** Cargo door openings and loading door openings shall be equipped with weather seals that restrict air leakage and provide direct contact along the top and sides of vehicles that are parked in the doorway.

~~C402.5.10~~ **Recessed lighting.** Recessed luminaires installed in the *building thermal envelope* shall be all of the following:

1. ~~IC rated.~~
2. ~~Labeled as having an air leakage rate of not more 2.0 cfm (0.944 L/s) when tested in accordance with ASTM E283 at a 1.57 psf (75 Pa) pressure differential.~~
3. ~~Sealed with a gasket or caulk between the housing and interior wall or ceiling covering.~~

~~C402.5.11~~ **C402.5.8 Operable openings interlocking.** Where occupancies utilize operable openings to the outdoors that are larger than 40 square feet (3.7 m²) in area, such openings shall be interlocked with the heating and cooling system so as to raise the cooling setpoint to 90°F (32°C) and lower the heating setpoint to 55°F (13°C) whenever the operable opening is open. The change in heating and cooling setpoints shall occur within 10 minutes of opening the operable opening.

Exceptions:

1. Operable openings into ~~Separately~~ separately zoned areas associated with the preparation of food that contain appliances that contribute to the HVAC loads of a restaurant or similar type of occupancy.
2. ~~Warehouses~~ Storage occupancies that utilize overhead doors for the function of the occupancy, where ~~approved~~ approved by the code official.
3. ~~The first entrance doors where~~ Doors located in the exterior wall ~~and that~~ are part of a vestibule system.

~~C402.5.11.1~~ C402.5.8.1 Operable controls. Controls shall comply with Section C403.13.

**SECTION C403
BUILDING MECHANICAL SYSTEMS**

TABLE C403.1.2(1)
**MAXIMUM DESIGN MECHANICAL LOAD COMPONENT
(DESIGN MLC)**

CLIMATE ZONE	DESIGN MLC AT 100% AND AT 50% ITE LOAD
0A	0.24
0B	0.26
1A	0.23
2A	0.24
3A	0.23
4A	0.23
5A	0.22
6A	0.22
1B	0.28
2B	0.27
3B	0.26
4B	0.23
5B	0.23
6B	0.21
3C	0.19
4C	0.21
5C	0.19
7	0.20
8	0.19

TABLE C403.1.2(2)
MAXIMUM ANNUALIZED MECHANICAL LOAD COMPONENT (ANNUALIZED MLC)

CLIMATE ZONE	HVAC MAXIMUM ANNUALIZED MLC AT 100% AND AT 50% ITE LOAD
0A	0.19
0B	0.20
1A	0.18
2A	0.19
3A	0.18

4A	0.17
5A	0.17
6A	0.17
1B	0.16
2B	0.18
3B	0.18
4B	0.18
5B	0.16
6B	0.17
3C	0.16
4C	0.16
5C	0.16
7	0.16
8	0.16

C403.2.2 Ventilation. Ventilation, either natural or mechanical, shall be provided in accordance with Chapter 4 of the *International Mechanical Code*. ~~Where mechanical ventilation is provided, the system shall provide the capability to reduce the outdoor air supply to the minimum required by Chapter 4 of the *International Mechanical Code*.~~

C403.2.3 Fault detection and diagnostics. New buildings with an HVAC system serving a gross conditioned floor area of ~~100,000~~ 20,000 square feet (9290 m²) or larger shall include a fault detection and diagnostics (FDD) system to monitor the HVAC system’s performance and automatically identify faults. The FDD system shall:

1. Include permanently installed sensors and devices to monitor the HVAC system’s performance.
 2. ~~Sample the HVAC system’s performance at least once every 15 minutes.~~
 3. Automatically identify and report HVAC system faults.
 4. Automatically notify authorized personnel of identified HVAC system faults.
 5. Automatically provide prioritized recommendations for repair of identified faults based on analysis of data collected from the sampling of HVAC system performance.
6. Be capable of transmitting the prioritized fault repair recommendations to remotely located authorized personnel.

C403.4.3.3.2 Heat rejection. The following shall apply to hydronic water loop heat pump systems in Climate Zones 3 through 5:

1. Where a closed-circuit cooling tower is used directly in the heat pump loop, either an automatic valve shall be installed to bypass the flow of water around the closed-circuit cooling tower, except for any flow necessary for freeze protection, or low-leakage positive-closure dampers shall be provided.
2. Where an open-circuit cooling tower is used directly in the heat pump loop, an automatic valve shall be installed to bypass all heat pump water flow around the open-circuit cooling tower.
3. Where an open-circuit or closed-circuit cooling tower is used in conjunction with a separate heat exchanger to isolate the open-circuit cooling tower from the heat pump loop, heat loss shall be controlled by shutting down the circulation pump on the cooling tower loop.

Exception: Where it can be demonstrated that a heat pump system will be required to reject heat throughout the year.

**TABLE C403.4.4
VARIABLE SPEED DRIVE (VSD) REQUIREMENTS FOR DEMAND-CONTROLLED PUMPS**

CHILLED WATER AND HEAT REJECTION LOOP PUMPS IN THESE CLIMATE ZONES	HEATING WATER PUMPS IN THESE CLIMATE ZONES	VSD REQUIRED FOR MOTORS WITH RATED OUTPUT OF:
0A, 0B, 1A, 1B, 2B	—	≥ 2 hp
2A, 3B	—	≥ 3 hp
3A, 3C, 4A, 4B	7, 8	≥ 5 hp
4C, 5A, 5B, 5C, 6A, 6B	3C, 5A-5C, 6A, 6B	≥ 7.5 hp
—	4A, 4C, 5B	≥ 10 hp
7, 8	4B	≥ 15 hp
—	2A, 2B, 3A, 3B	≥ 25 hp
—	0B, 1B	≥ 100 hp
—	0A, 1A	≥ 200 hp

For SI: 1 hp = 0.746 kW.

C403.5 Economizers. Economizers shall comply with Sections C403.5.1 through C403.5.5.

An air or water economizer shall be provided for the following cooling systems:

- Chilled water systems with a total cooling capacity, less cooling capacity provided with air economizers, as specified in Table C403.5(1).
- Individual fan systems with cooling capacity greater than ~~or equal to 54,000~~ 60,000 Btu/h (~~15.8~~ 17.6 kW) in buildings having other than a *Group R* occupancy.
The total supply capacity of all fan cooling units not provided with economizers shall not exceed 20 percent of the total supply capacity of all fan cooling units in the building or 300,000 Btu/h (88 kW), whichever is greater.
- Individual fan systems with cooling capacity greater than or equal to 270,000 Btu/h (79.1 kW) in buildings having a *Group R* occupancy.
The total supply capacity of all fan cooling units not provided with economizers shall not exceed 20 percent of the total supply capacity of all fan cooling units in the building or 1,500,000 Btu/h (440 kW), whichever is greater.

Exceptions: Economizers are not required for the following systems.

- Individual fan systems not served by chilled water for buildings located in *Climate Zones* 0A, 0B, 1A and 1B.
- Where more than 25 percent of the air designed to be supplied by the system is to spaces that are designed to be humidified above 35°F (1.7°C) dew-point temperature to satisfy process needs.
- Systems expected to operate less than 20 hours per week.
- Systems serving supermarket areas with open refrigerated casework.
- Where the cooling efficiency is greater than or equal to the efficiency requirements in Table C403.5(2).
- Systems that include a heat recovery system in accordance with Section C403.10.5.
- VRF systems installed with a dedicated outdoor air system.

**TABLE C403.5(1)
MINIMUM CHILLED-WATER SYSTEM COOLING CAPACITY FOR DETERMINING ECONOMIZER COOLING REQUIREMENTS**

CLIMATE ZONES (COOLING)	TOTAL CHILLED-WATER SYSTEM CAPACITY LESS CAPACITY OF COOLING UNITS WITH AIR ECONOMIZERS

	Local water-cooled chilled-water systems	Air-cooled chilled-water systems or district chilled-water systems
0A, 1A	Economizer not required	Economizer not required
0B, 1B, 2A, 2B	960,000 Btu/h	1,250,000 Btu/h
3A, 3B, 3C, 4A, 4B, 4C	720,000 Btu/h	940,000 Btu/h
5A, 5B, 5C, 6A, 6B, 7, 8	1,320,000 Btu/h	1,720,000 Btu/h

For SI: 1 British thermal unit per hour = 0.2931 W.

TABLE C403.5(2)
EQUIPMENT EFFICIENCY PERFORMANCE EXCEPTION
FOR ECONOMIZERS

CLIMATE ZONES	COOLING EQUIPMENT PERFORMANCE IMPROVEMENT (EER OR IPLV)
2A, 2B	10% efficiency improvement
3A, 3B	15% efficiency improvement
4A, 4B	20% efficiency improvement

C403.6.5 Supply-air temperature reset controls. Multiple-zone HVAC systems shall include controls that are capable of and configured to automatically reset the supply-air temperature in response to representative building loads, or to outdoor air temperature. The controls shall be configured to reset the supply air temperature not less than 25 percent of the difference between the design supply-air temperature and the design room air temperature. Controls that adjust the reset based on zone humidity are allowed in Climate Zones ~~0B, 1B, 2B, 3B, 3C~~ and 4 through ~~5, 8~~. HVAC zones that are expected to experience relatively constant loads shall have maximum airflow designed to accommodate the fully reset supply-air temperature.

Exceptions:

1. Systems that prevent reheating, recooling or mixing of heated and cooled supply air.
2. Seventy-five percent of the energy for reheating is from site-recovered or site-solar energy sources.
3. Systems in Climate Zones ~~0A, 1A and 3A~~ with less than 3,000 cfm (1500 L/s) of design outside air.
4. ~~Systems in Climate Zone 2A with less than 10,000 cfm (5000 L/s) of design outside air. Deleted.~~
5. Systems in Climate Zones ~~0A, 1A, 2A and 3A~~ with not less than 80 percent outside air and employing exhaust air energy recovery complying with Section C403.7.4.

C403.6.5.1 Dehumidification control interaction. In Climate Zones ~~0A, 1A, 2A and 3A~~, the system design shall allow supply-air temperature *reset* while dehumidification is provided. When dehumidification *control* is active, air economizers shall be locked out.

C403.7.4.1 Nontransient dwelling units. Nontransient dwelling units shall be provided with outdoor air energy recovery ventilation systems with an enthalpy recovery ratio of not less than 50 percent at cooling design condition and not less than 60 percent at heating design condition.

Exceptions:

1. ~~Nontransient dwelling units in Climate Zone 3C. Deleted.~~
2. ~~Nontransient dwelling units with not more than 500 square feet (46 m²) of conditioned floor area in Climate Zones 0, 1, 2, 3, 4C and 5C. Deleted.~~

3. ~~Enthalpy recovery ratio requirements at heating design condition in Climate Zones 0, 1 and 2. Deleted.~~
4. ~~Enthalpy recovery ratio requirements at cooling design condition in Climate Zones 4, and 5, 6, 7 and 8. Deleted.~~

C403.7.4.2 Spaces other than nontransient dwelling units. Where the supply airflow rate of a fan system serving a space other than a nontransient dwelling unit exceeds the values specified in Tables C403.7.4.2(1) and C403.7.4.2(2), the system shall include an energy recovery system. The energy recovery system shall provide an enthalpy recovery ratio of not less than 50 percent at design conditions. Where an air economizer is required, the energy recovery system shall include a bypass or controls that permit operation of the economizer as required by Section C403.5.

Exception: An energy recovery ventilation system shall not be required in any of the following conditions:

1. Where energy recovery systems are prohibited by the *International Mechanical Code*.
2. Laboratory fume hood systems that include not fewer than one of the following features:
 - 2.1. Variable-air-volume hood exhaust and room supply systems configured to reduce exhaust and makeup air volume to 50 percent or less of design values.
 - 2.2. Direct makeup (auxiliary) air supply equal to or greater than 75 percent of the exhaust rate, heated not warmer than 2°F (1.1°C) above room setpoint, cooled to not cooler than 3°F (1.7°C) below room setpoint, with no humidification added, and no simultaneous heating and cooling used for dehumidification control.
3. Systems serving spaces that are heated to less than 60°F (15.5°C) and that are not cooled.
4. Where more than 60 percent of the outdoor heating energy is provided from site-recovered or site-solar energy.
5. ~~Enthalpy recovery ratio requirements at heating design condition in Climate Zones 1 and 2. Deleted.~~
6. ~~Enthalpy recovery ratio requirements at cooling design condition in Climate Zones 3C, 4C, 5B, 5C, 6B, 7 and 8. Deleted.~~
7. Systems requiring dehumidification that employ energy recovery in series with the cooling coil.
8. Where the largest source of air exhausted at a single location at the building exterior is less than 75 percent of the design *outdoor air* flow rate.
9. Systems expected to operate less than 20 hours per week at the *outdoor air* percentage covered by Table C403.7.4.2(1).
10. Systems exhausting toxic, flammable, paint or corrosive fumes or dust.
11. Commercial kitchen hoods used for collecting and removing grease vapors and smoke.

C403.7.6.2 Ventilation controls. Controls shall be provided on each HVAC system that are capable of and configured to automatically turn off the ventilation and exhaust fans within 20 minutes after ~~of the occupants leaving~~ leave the guestroom, or *isolation devices* shall be provided to each guestroom that are capable of automatically shutting off the supply of outdoor air to and exhaust air from the guestroom.

Exception: Guestroom ventilation systems are not precluded from having an automatic daily pre-occupancy purge cycle that provides daily outdoor air ventilation during unrented periods at the design ventilation rate for 60 minutes, or at a rate and duration equivalent to one air change.

C403.7.7 Shutoff dampers. Outdoor air intake and exhaust openings and stairway and shaft vents shall be provided with Class I motorized dampers. The dampers shall have an air leakage rate not greater than 4 cfm/ft² (20.3 L/s × m²) of damper surface area at 1.0 inch water gauge (249 Pa) and shall be labeled by an *approved agency* when tested in accordance with AMCA 500D for such purpose.

Outdoor air intake and exhaust dampers shall be installed with automatic controls configured to close when the systems or spaces served are not in use or during unoccupied period warm-up and setback operation, unless the systems served require outdoor or exhaust air in accordance with the *International Mechanical Code* or the dampers are opened to provide intentional economizer cooling.

Stairway and shaft vent dampers shall be installed with automatic controls configured to open upon the activation of any fire alarm initiating device of the building's fire alarm system or the interruption of power to the damper.

Exception: Nonmotorized gravity dampers shall be an alternative to motorized dampers for exhaust and relief openings as follows:

1. In buildings less than three stories in height above grade plane.
2. In buildings of any height located in *Climate Zones 0, 1, 2 or 3*.
3. Where the design exhaust capacity is not greater than 300 cfm (142 L/s).

C403.12.1 Duct and plenum insulation and sealing. Supply and return air ducts and plenums shall be insulated with not less than R-6 insulation where located in unconditioned spaces and where located outside the building with not less than R-8 insulation in *Climate Zones 3* through 4 and not less than R-12 insulation in *Climate Zones 5* through 8. Ducts located underground beneath buildings shall be insulated as required in this section or have an equivalent thermal distribution efficiency. Underground ducts utilizing the thermal distribution efficiency method shall be *listed* and *labeled* to indicate the *R*-value equivalency. Where located within a building envelope assembly, the duct or plenum shall be separated from the building exterior or unconditioned or exempt spaces by not less than R-8 insulation in *Climate Zones 3* through 4 and not less than R-12 insulation in *Climate Zones 5* through 8.

Exceptions:

1. Where located within equipment.
2. Where the design temperature difference between the interior and exterior of the duct or plenum is not greater than 15°F (8°C).

Ducts, air handlers and filter boxes shall be sealed. Joints and seams shall comply with Section 603.9 of the *International Mechanical Code*.

SECTION C404 SERVICE WATER HEATING

SECTION C405 ELECTRICAL POWER AND LIGHTING SYSTEMS

C405.2.4.2 Sidelit daylight zone. The sidelit daylight zone is the floor area adjacent to vertical *fenestration* that complies with all of the following:

1. Where the fenestration is located in a wall, the sidelit daylight zone shall extend laterally to the nearest full-height wall, or up to 1.0 times the height from the floor to the top of the fenestration, and longitudinally from the edge of the fenestration to the nearest full-height wall, or up to 0.5 times the height from the floor to the top of the fenestration, whichever is less, as indicated in Figure C405.2.4.2(1).
2. Where the fenestration is located in a rooftop monitor, the sidelit daylight zone shall extend laterally to the nearest obstruction that is taller than 0.7 times the ceiling height, or up to 1.0 times the height from the floor to the bottom of the fenestration, whichever is less, and longitudinally from the edge of the fenestration to the nearest obstruction that is taller than 0.7 times the ceiling height, or up to 0.25 times the height from the floor to the bottom of the fenestration, whichever is less, as indicated in Figures C405.2.4.2(2) and C405.2.4.2(3).
3. The secondary sidelit daylight zone is directly adjacent to the primary sidelit daylight zone and shall extend laterally to 2.0 times the height from the floor to the top of the fenestration or to the nearest full height wall, whichever is less, and longitudinally from the edge of the fenestration to the nearest full height wall, or up to 2 feet, whichever is less, as indicated in Figure C405.2.4.2(1). ~~The area of secondary sidelit zones shall not be considered in the calculation of the daylight zones in Section C402.4.1.1.~~
4. The area of the fenestration is not less than 24 square feet (2.23 m²).
5. The distance from the fenestration to any building or geological formation that would block *access to* daylight is greater than one-half of the height from the bottom of the fenestration to the top of the building or geologic formation.
6. The visible transmittance of the fenestration is not less than 0.20.

7. The projection factor (determined in accordance with Equation 4-5) for any overhanging projection that is shading the fenestration is not greater than 1.0 for fenestration oriented 45 degrees or less from true north and not greater than 1.5 for all other orientations.

C405.12 Energy monitoring. New buildings with a gross *conditioned floor area* of ~~25,000~~ 20,000 square feet (2322 m²) or larger shall be equipped to measure, monitor, record and report energy consumption data in compliance with Sections C405.12.1 through C405.12.5.

Exception: R-2 occupancies and individual tenant spaces are not required to comply with this section provided that the space has its own utility services and meters and has less than 5,000 square feet (464.5 m²) of *conditioned floor area*.

C405.12.5 Graphical energy report. A permanent and readily accessible reporting mechanism shall be provided in the building that is accessible by to building operation and management personnel. The reporting mechanism shall have the capability to graphically provide the energy consumption for each end-use category required by Section C405.12.2 at least every hour, day, month and year for the previous 36 months.

SECTION C406 ADDITIONAL EFFICIENCY REQUIREMENTS

~~**C406.9 Reduced air infiltration.** Air infiltration shall be verified by whole building pressurization testing conducted in accordance with ASTM E779 or ASTM E1827 by an independent third party. The measured air leakage rate of the building envelope shall not exceed 0.25 cfm/ft² (2.0 L/s × m²) under a pressure differential of 0.3 inches water column (75 Pa), with the calculated surface area being the sum of the above and below grade building envelope. A report that includes the tested surface area, floor area, air by volume, stories above grade, and leakage rates shall be submitted to the code official and the building owner.~~

~~**Exception:** For buildings having over 250,000 square feet (25 000 m²) of *conditioned floor area*, air leakage testing need not be conducted on the whole building where testing is conducted on representative above grade sections of the building. Tested areas shall total not less than 25 percent of the conditioned floor area and shall be tested in accordance with this section.~~

C406.9 Reduced air leakage. Air leakage of the building thermal envelope shall be tested by an approved third party in accordance with Section C402.5.2.1 and shall comply with one of the following:

1. The measured air leakage shall not exceed 0.22 cfm/ft² (1.1 L/s × m²) of the building thermal envelope at a pressure differential of 0.3 inch water gauge (75 Pa), with the calculated surface area being the sum of the above- and below-grade building thermal envelope. ~~Exception:~~
2. Buildings tested in accordance with C402.5.2 shall have a weighted average of all tested unit results that is not greater than 0.15 cfm/ft² (1.0 L/s x m²) at a pressure differential of 0.2 inch water gauge (50 Pa), or 0.20 cfm/ft² at a pressure differential of 75Pa (0.30 in w.g.) in accordance with Table C406.9.

Table C406.9

Pressure Differential (Pa)	Test pressure Adjustment Factor	Max Air Leakage / Building Thermal Envelope (CFM/ ft ²)	
75 (0.30 in. w.g.)		0.20	0.22
50 (0.20 in. w.g.)	0.752897957	0.15	0.17
Example: If maximum air leakage allowed is 0.15 cfm/ft ² of bldg thermal envelope at 50 Pa(0.2 in w.g.), the corresponding maximum leakage rate is 0.20 cfm/SF of bldg thermal envelope if using a higher test pressure of 75 Pa(0.3 in w.g.)			

C406.10.5 Graphical energy report. A permanent and readily accessible reporting mechanism shall be provided in the building that is accessible by building operation and management personnel. The reporting mechanism shall have the capability to graphically provide the energy consumption for each end-use category required by Section C406.10.2 at least every hour, day, month and year for the previous 36 months.

C406.11 Fault detection and diagnostics system. A fault detection and diagnostics system shall be installed to monitor the HVAC system’s performance and automatically identify faults. The system shall do all of the following:

1. Include permanently installed sensors and devices to monitor the HVAC system’s performance.
2. ~~Sample the HVAC system’s performance at least once every 15 minutes.~~ Deleted.
3. Automatically identify and report HVAC system faults.
4. Automatically notify authorized personnel of identified HVAC system faults.
5. Automatically provide prioritized recommendations for repair of identified faults based on analysis of data collected from the sampling of the HVAC system performance.
6. Be capable of transmitting the prioritized fault repair recommendations to remotely located authorized personnel.

**SECTION C407
TOTAL BUILDING PERFORMANCE**

**SECTION C408
MAINTENANCE INFORMATION
AND SYSTEM COMMISSIONING**

**TABLE C402.5.4 Table C402.5.3
MAXIMUM AIR LEAKAGE RATE FOR FENESTRATION ASSEMBLIES**

FENESTRATION ASSEMBLY	MAXIMUM RATE (CFM/FT ²)	TEST PROCEDURE
Windows	0.20 ^a	AAMA/WDMA/CSA101/I.S.2/A440 or NFRC 400
Sliding doors	0.20 ^a	
Swinging doors	0.20 ^a	
Skylights—with condensation weepage openings	0.30	
Skylights—all other	0.20 ^a	
Curtain walls	0.06	NFRC 400 or ASTM E283 at 1.57 psf (75 Pa)
Storefront glazing	0.06	
Commercial glazed swinging entrance doors	1.00	
Power-operated sliding doors and power operated folding doors	1.00	
Revolving doors	1.00	
Garage doors	0.40	

Rolling doors	1.00	ANSI/DASMA 105, NFRC 400, or ASTM E283 at 1.57 psf (75 Pa)
High-speed doors	1.30	

For SI: 1 cubic foot per minute = 0.47 L/s, 1 square foot = 0.093 m².

a. The maximum rate for windows, sliding and swinging doors, and skylights is permitted to be 0.3 cfm per square foot of fenestration or door area when tested in accordance with AAMA/WDMA/CSA101/I.S.2/A440 at 6.24 psf (300 Pa).

TABLE C406.1(5)
ADDITIONAL ENERGY EFFICIENCY CREDITS FOR OTHER^a OCCUPANCIES

SECTION	CLIMATE ZONE																
	0A & 1A	0B & 1B	2A	2B	3A	3B	3C	4A	4B	4C	5A	5B	5C	6A	6B	7	8
C406.2.1: 5% heating efficiency improvement	NA	NA	NA	NA	1	1	1	1	1	2	1	2	1	2	2	3	3
C406.2.2: 5% cooling efficiency improvement	5	5	4	4	3	3	2	2	2	1	1	2	1	1	1	1	1
C406.2.3: 10% heating efficiency improvement	NA	NA	NA	1	1	1	1	2	2	3	3	3	3	4	3	5	5
C406.2.4: 10% cooling efficiency improvement	8	9	8	7	5	5	3	4	4	2	2	3	2	2	2	2	2
C406.3: Reduced lighting power	8	8	9	9	9	9	10	8	9	9	7	8	8	8	8	8	7
C406.4: Enhanced digital lighting controls	2	2	2	2	2	2	2	2	2	2	2	3	2	2	2	2	1
C406.5: On-site renewable energy	8	8	8	8	8	8	8	8	8	7	7	7	7	7	7	7	7
C406.6: Dedicated outdoor air system	3	4	3	3	4	3	2	5	3	3	5	4	3	7	5	7	6
C406.7.2: Recovered or renewable water heating ^b	10	9	11	10	13	12	15	14	14	15	14	14	16	14	15	15	15
C406.7.3: Efficient fossil fuel water heater ^b	5	5	6	6	8	7	8	8	8	9	9	9	10	10	9	10	11
C406.7.4: Heat pump water heater ^b	6	5	5	5	5	5	5	5	5	5	5	5	5	5	5	5	5
C406.8: Enhanced envelope performance	3	6	3	4	3	4	1	5	4	3	5	5	4	7	6	9	10
C406.9: Reduced air infiltration	3	2	2	4	4	2	NA	6	2	2	6	4	1	10	5	7	4
C406.10: Energy monitoring	3	3	3	3	3	3	3	3	3	3	2	3	2	2	2	3	2
C406.11: Fault detection and diagnostics system	2	2	2	2	1	1	1	1	1	1	1	1	1	1	1	1	1

NA = Not Applicable.

- a. Other occupancy groups include all groups except Groups B, E, I, M and R.
- b. For occupancy groups listed in Section C406.7.1.

TABLE C406.1(2)
ADDITIONAL ENERGY EFFICIENCY CREDITS FOR GROUP R AND I OCCUPANCIES

SECTION	CLIMATE ZONE																
	0A & 1A	0B & 1B	2A	2B	3A	3B	3C	4A	4B	4C	5A	5B	5C	6A	6B	7	8
C406.2.1: 5% heating efficiency improvement	NA	NA	NA	NA	1	NA	NA	1	NA	+	1	+	+	2	+	2	2
C406.2.2: 5% cooling efficiency improvement	3	3	2	2	1	+	+	1	+	NA	1	+	NA	+	+	+	NA
C406.2.3: 10% heating efficiency improvement	NA	NA	NA	NA	1	NA	NA	1	+	+	2	2	+	3	2	3	4
C406.2.4: 10% cooling efficiency improvement	5	5	4	3	2	3	+	2	2	+	1	+	+	+	+	+	+
C406.3: Reduced lighting power	2	2	2	2	2	2	2	2	2	2	2	2	2	2	2	2	2
C406.4: Enhanced digital lighting controls	NA	NA	NA	NA	NA	NA	NA	NA	NA	NA	NA	NA	NA	NA	NA	NA	NA
C406.5: On-site renewable energy	8	8	8	8	7	8	8	7	7	7	7	7	7	7	7	7	7
C406.6: Dedicated outdoor air system	3	4	3	3	4	2	NA	6	3	4	8	5	5	10	7	11	12
C406.7.2: Recovered or renewable water heating	10	9	11	10	13	12	15	14	14	15	14	14	16	14	15	15	15
C406.7.3: Efficient fossil fuel water heater	5	5	6	6	8	7	8	8	8	9	9	9	10	10	9	10	11
C406.7.4: Heat pump water heater	6	5	5	5	5	5	5	5	5	5	5	5	5	5	5	5	5
C406.8: Enhanced envelope performance	3	6	3	5	4	4	+	4	3	3	4	5	3	5	4	6	6
C406.9: Reduced air infiltration	6	5	3	11	6	4	NA	7	3	3	9	5	+	13	6	8	3
C406.10: Energy monitoring	+	+	+	+	1	+	+	1	+	+	1	+	+	+	+	+	+
C406.11: Fault detection and diagnostics system	+	+	+	+	1	+	NA	1	+	NA	1	+	NA	+	+	+	+

NA = Not Applicable.

TABLE C406.1(4)
ADDITIONAL ENERGY EFFICIENCY CREDITS FOR GROUP M OCCUPANCIES

SECTION	CLIMATE ZONE																
	0A & 1A	0B & 1B	2A	2B	3A	3B	3C	4A	4B	4C	5A	5B	5C	6A	6B	7	8
C406.2.1: 5% heating efficiency improvement	NA	NA	NA	NA	1	+	NA	1	+	2	2	2	2	3	2	3	4

C406.2.2: 5% cooling efficiency improvement	5	6	4	4	3	3	1	2	2	1	1	2	NA	1	1	1	NA
C406.2.3: 10% heating efficiency improvement	NA	NA	NA	1	1	1	1	2	2	4	3	4	5	5	3	6	8
C406.2.4: 10% cooling efficiency improvement	9	12	9	8	6	6	3	4	4		2	3	NA	2	2	2	1
C406.3: Reduced lighting power	13	13	15	14	16	14	17	15	15	14	12	14	14	16	16	14	12
C406.4: Enhanced digital lighting controls	3	3	4	3	4	3	4	4	4	3	3	3	3	4	4	3	3
C406.5: On-site renewable energy	8	8	8	8	8	8	8	8	8	7	7	7	7	7	7	7	6
C406.6: Dedicated outdoor air system	3	4	3	3	3	3	1	3	2	2	2	3	2	4	3	4	4
C406.7.2: Recovered or renewable water heating	NA	NA	NA	NA	NA	NA	NA	NA	NA	NA	NA	NA	NA	NA	NA	NA	NA
C406.7.3: Efficient fossil fuel water heater	NA	NA	NA	NA	NA	NA	NA	NA	NA	NA	NA	NA	NA	NA	NA	NA	NA
C406.7.4: Heat pump water heater	NA	NA	NA	NA	NA	NA	NA	NA	NA	NA	NA	NA	NA	NA	NA	NA	NA
C406.8: Enhanced envelope performance	4	6	3	4	3	3	1	6	4	4	4	5	4	6	5	8	9
C406.9: Reduced air infiltration	1	1	1	2	1	1	NA	3	1	1	3	2	1	7	3	6	3
C406.10: Energy monitoring	4	5	5	5	5	4	4	4	4	3	3	4	3	4	4	4	3
C406.11: Fault detection and diagnostics system	2	2	2	2	1	1	1	1	1	1	1	1	1	1	1	2	2

NA = Not Applicable.

TABLE C406.1(3)
ADDITIONAL ENERGY EFFICIENCY CREDITS FOR GROUP E OCCUPANCIES

SECTION	CLIMATE ZONE																
	0A & 1A	0B & 1B	2A	2B	3A	3B	3C	4A	4B	4C	5A	5B	5C	6A	6B	7	8
C406.2.1: 5% heating efficiency improvement	NA	NA	NA	NA	1	1	1	1	1	2	1	2	1	2	2	3	4
C406.2.2: 5% cooling efficiency improvement	4	4	3	3	2	2	2	2	1	1	1	1	NA	1	1	1	NA
C406.2.3: 10% heating efficiency improvement	NA	NA	NA	1	1	1	1	2	3	4	3	4	3	4	3	5	7
C406.2.4: 10% cooling efficiency improvement	7	8	7	6	5	4	3	4	3	1	2	2	1	2	2	2	1
C406.3: Reduced lighting power	8	8	8	9	8	9	9	8	9	9	8	9	8	7	8	7	7

C406.7.3: Efficient fossil fuel water heater	NA	NA	NA	NA	NA	NA	NA	NA	NA	NA	NA	NA	NA	NA	NA	NA	NA
C406.7.4: Heat pump water heater	NA	NA	NA	NA	NA	NA	NA	NA	NA	NA	NA	NA	NA	NA	NA	NA	NA
C406.8: Enhanced envelope performance	4	4	4	4	4	3	NA	7	4	5	10	7	6	11	10	14	16
C406.9: Reduced air infiltration	2	1	1	2	4	1	NA	8	2	3	11	4	1	15	8	11	6
C406.10: Energy monitoring	4	4	4	4	3	3	3	3	3	3	2	3	2	2	2	2	2
C406.11: Fault detection and diagnostics system	2	2	2	2	1	1	1	1	1	1	1	1	1	1	1	1	1

NA = Not Applicable.

**TABLE C403.5.3.3
HIGH-LIMIT SHUTOFF CONTROL SETTING FOR AIR ECONOMIZERS^b**

DEVICE TYPE	CLIMATE ZONE	REQUIRED HIGH LIMIT (ECONOMIZER OFF WHEN):	
		Equation	Description
Fixed dry bulb	0B, 1B, 2B, 3B, 3C, 4B, 4C, 5B, 5C, 6B, 7, 8	$T_{OA} > 75^{\circ}\text{F}$	Outdoor air temperature exceeds 75°F
	5A, 6A	$T_{OA} > 70^{\circ}\text{F}$	Outdoor air temperature exceeds 70°F
	0A, 1A, 2A, 3A, 4A	$T_{OA} > 65^{\circ}\text{F}$	Outdoor air temperature exceeds 65°F
Differential dry bulb	0B, 1B, 2B, 3B, 3C, 4B, 4C, 5A, 5B, 5C, 6A, 6B, 7, 8	$T_{OA} > T_{RA}$	Outdoor air temperature exceeds return air temperature
Fixed enthalpy with fixed dry-bulb temperatures	All	$h_{OA} > 28 \text{ Btu/lb}^a$ or $T_{OA} > 75^{\circ}\text{F}$	Outdoor air enthalpy exceeds 28 Btu/lb of dry air ^a or Outdoor air temperature exceeds 75°F
Differential enthalpy with fixed dry-bulb temperature	All	$h_{OA} > h_{RA}$ or $T_{OA} > 75^{\circ}\text{F}$	Outdoor air enthalpy exceeds return air enthalpy or Outdoor air temperature exceeds 75°F

For SI: $^{\circ}\text{C} = (^{\circ}\text{F} - 32)/1.8$, 1 Btu/lb = 2.33 kJ/kg.

- At altitudes substantially different than sea level, the fixed enthalpy limit shall be set to the enthalpy value at 75°F and 50-percent relative humidity. As an example, at approximately 6,000 feet elevation, the fixed enthalpy limit is approximately 30.7 Btu/lb.
- Devices with selectable setpoints shall be capable of being set to within 2°F and 2 Btu/lb of the setpoint listed.

**TABLE C403.7.4.2(1)
ENERGY RECOVERY REQUIREMENT (Ventilation systems operating less than 8,000 hours per year)**

CLIMATE ZONE	PERCENT (%) OUTDOOR AIR AT FULL DESIGN AIRFLOW RATE							
	≥ 10% and < 20%	≥ 20% and < 30%	≥ 30% and < 40%	≥ 40% and < 50%	≥ 50% and < 60%	≥ 60% and < 70%	≥ 70% and < 80%	≥ 80%
	Design Supply Fan Airflow Rate (cfm)							

3B, 3C, 4B, 4C, 5B	NR	NR	NR	NR	NR	NR	NR	NR
0B, 1B, 2B, 5C	NR	NR	NR	NR	≥ 26,000	≥ 12,000	≥ 5,000	≥ 4,000
6B	≥ 28,000	≥ 26,5000	≥ 11,000	≥ 5,500	≥ 4,500	≥ 3,500	≥ 2,500	≥ 1,500
0A, 1A, 2A, 3A, 4A, 5A, 6A	≥ 26,000	≥ 16,000	≥ 5,500	≥ 4,500	≥ 3,500	≥ 2,000	≥ 1,000	> 120
7, 8	≥ 4,500	≥ 4,000	≥ 2,500	≥ 1,000	> 140	> 120	> 100	> 80

For SI: 1 cfm = 0.4719 L/s.

NR = Not Required.

CHAPTER 5 [CE] EXISTING BUILDINGS

User note:

About this chapter: Many buildings are renovated or altered in numerous ways that could affect the energy use of the building as a whole. Chapter 5 requires the application of certain parts of Chapter 4 in order to maintain, if not improve, the conservation of energy by the renovated or altered building.

SECTION C503 ALTERATIONS

C503.1 General. Alterations to any building or structure shall comply with the requirements of Section C503. Alterations shall be such that the existing building or structure is not less conforming to the provisions of this code than the existing building or structure was prior to the alteration. Alterations to an existing building, building system or portion thereof shall conform to the provisions of this code as those provisions relate to new construction without requiring the unaltered portions of the existing building or building system to comply with this code. Alterations shall not create an unsafe or hazardous condition or overload existing building systems.

Exception: The following alterations need not comply with the requirements for new construction, provided that the energy use of the building is not increased:

1. Storm windows installed over existing fenestration.
2. Surface-applied window film installed on existing single-pane fenestration assemblies reducing solar heat gain, provided that the code does not require the glazing or fenestration to be replaced.
3. Existing ceiling, wall or floor cavities exposed during construction, provided that these cavities are filled with insulation. Minimally this shall require: 2x4 cavity – R-13, 2x6 cavity – R-19, 2x8 cavity – R-30, 2x10 cavity – R-30, 2x12 cavity – R-38. See Section C504 Repairs for more specific language for repairs. Cladding ventilation spaces shall not be required to be filled.
4. Construction where the existing roof, wall or floor cavity is not exposed.
5. Roof recover.
6. Air barriers shall not be required for roof recover and roof replacement where the alterations or renovations to the building do not include alterations, renovations or repairs to the remainder of the building envelope.

SECTION C504 REPAIRS

SECTION C505 CHANGE OF OCCUPANCY OR USE

C505.1 General. Spaces undergoing a change in occupancy that would result in an increase in demand for either fossil fuel or electrical energy shall comply with this code. Where the use in a space changes from one use in Table C405.3.2(1) or C405.3.2(2) to another use in Table C405.3.2(1) or C405.3.2(2), the installed lighting wattage shall comply with Section C405.3. Where the space undergoing a change in occupancy or use is in a building with a fenestration area that exceeds the limitations of Section C402.4.1, the space is exempt from Section C402.4.1 provided that there is not an increase in fenestration area.

Exceptions:

1. Where the component performance alternative in Section C402.1.5 is used to comply with this section, the proposed UA shall not be greater than 110 percent of the target UA.
2. Where the total building performance option in Section C407 is used to comply with this section, the annual energy cost of the proposed design shall not be greater than 110 percent of the annual energy cost otherwise permitted by Section ~~C407.3.~~ C407.2.

CHAPTER 6 [CE] REFERENCED STANDARDS

User note:

~~**About this chapter:** Chapter 6 lists the full title, edition year and address of the promulgator for all standards that are referenced in the code. The section numbers in which the standards are referenced are also listed.~~

~~This chapter lists the standards that are referenced in various sections of this document. The standards are listed herein by the promulgating agency of the standard, the standard identification, the effective date and title, and the section or sections of this document that reference the standard. The application of the referenced standards shall be as specified in Section 108.~~

APPENDIX CA

BOARD OF APPEALS—COMMERCIAL

The provisions contained in this appendix are not mandatory, unless specifically referenced in the adopting ordinance.

User note:

— **About this appendix:** Appendix CA provides criteria for Board of Appeals members. Also provided are procedures by which the Board of Appeals should conduct its business.

SECTION CA101 GENERAL

Deleted. See the North Carolina Administrative Code and Policies.

CA101.1 Scope. A board of appeals shall be established within the jurisdiction for the purpose of hearing applications for modification of the requirements of this code pursuant to the provisions of Section C110. The board shall be established and operated in accordance with this section, and shall be authorized to hear evidence from appellants and the code official pertaining to the application and intent of this code for the purpose of issuing orders pursuant to these provisions.

CA101.2 Application for appeal. Any person shall have the right to appeal a decision of the code official to the board. An application for appeal shall be based on a claim that the intent of this code or the rules legally adopted hereunder have been incorrectly interpreted, the provisions of this code do not fully apply or an equally good or better form of construction is proposed. The application shall be filed on a form obtained from the code official within 20 days after the notice was served.

CA101.2.1 Limitation of authority. The board shall not have authority to waive requirements of this code or interpret the administration of this code.

CA101.2.2 Stays of enforcement. Appeals of notice and orders, other than Imminent Danger notices, shall stay the enforcement of the notice and order until the appeal is heard by the board.

CA101.3 Membership of board. The board shall consist of five voting members appointed by the chief appointing authority of the jurisdiction. Each member shall serve for ~~[INSERT NUMBER OF YEARS]~~ years or until a successor has been appointed. The board member's terms shall be staggered at intervals, so as to provide continuity. The code official shall be an ex officio member of said board but shall not vote on any matter before the board.

CA101.3.1 Qualifications. The board shall consist of five individuals, who are qualified by experience and training to pass on matters pertaining to building construction and are not employees of the jurisdiction.

CA101.3.2 Alternate members. The chief appointing authority is authorized to appoint two alternate members who shall be called by the board chairperson to hear appeals during the absence or disqualification of a member. Alternate members shall possess the qualifications required for board membership, and shall be appointed for the same term or until a successor has been appointed.

CA101.3.3 Vacancies. Vacancies shall be filled for an unexpired term in the same manner in which original appointments are required to be made.

CA101.3.4 Chairperson. The board shall annually select one of its members to serve as chairperson.

CA101.3.5 Secretary. The chief appointing authority shall designate a qualified clerk to serve as secretary to the board. The secretary shall file a detailed record of all proceedings which shall set forth the reasons for the board's decision, the vote of each member, the absence of a member and any failure of a member to vote.

CA101.3.6 Conflict of interest. A member with any personal, professional or financial interest in a matter before the board shall declare such interest and refrain from participating in discussions, deliberations and voting on such matters.

CA101.3.7 Compensation of members. Compensation of members shall be determined by law.

~~**CA101.3.8 Removal from the board.** A member shall be removed from the board prior to the end of their terms only for cause. Any member with continued absence from regular meeting of the board may be removed at the discretion of the chief appointing authority.~~

~~**CA101.4 Rules and procedures.** The board shall establish policies and procedures necessary to carry out its duties consistent with the provisions of this code and applicable state law. The procedures shall not require compliance with strict rules of evidence, but shall mandate that only relevant information be presented.~~

~~**CA101.5 Notice of meeting.** The board shall meet upon notice from the chairperson, within 10 days of the filing of an appeal or at stated periodic intervals.~~

~~**CA101.5.1 Open hearing.** All hearings before the board shall be open to the public. The appellant, the appellant's representative, the code official and any person whose interests are affected shall be given an opportunity to be heard.~~

~~**CA101.5.2 Quorum.** Three members of the board shall constitute a quorum.~~

~~**CA101.5.3 Postponed hearing.** When five members are not present to hear an appeal, either the appellant or the appellant's representative shall have the right to request a postponement of the hearing.~~

~~**CA101.6 Legal counsel.** The jurisdiction shall furnish legal counsel to the board to provide members with general legal advice concerning matters before them for consideration. Members shall be represented by legal counsel at the jurisdiction's expense in all matters arising from service within the scope of their duties.~~

~~**CA101.7 Board decision.** The board shall only modify or reverse the decision of the code official by a concurring vote of three or more members.~~

~~**CA101.7.1 Resolution.** The decision of the board shall be by resolution. Every decision shall be promptly filed in writing in the office of the code official within three days and shall be open to the public for inspection. A certified copy shall be furnished to the appellant or the appellant's representative and to the code official.~~

~~**CA101.7.2 Administration.** The code official shall take immediate action in accordance with the decision of the board.~~

~~**CA101.8 Court review.** Any person, whether or not a previous party of the appeal, shall have the right to apply to the appropriate court for a writ of certiorari to correct errors of law. Application for review shall be made in the manner and time required by law following the filing of the decision in the office of the chief administrative officer.~~

APPENDIX CB SOLAR-READY ZONE—COMMERCIAL

The provisions contained in this appendix are not mandatory. ~~unless specifically referenced in the adopting ordinance.~~

User note:

~~**About this appendix:** Appendix CB is intended to encourage the installation of renewable energy systems by preparing buildings for the future installation of solar energy equipment, piping and wiring.~~

SECTION CB101 SCOPE

SECTION CB102 GENERAL DEFINITION

SECTION CB103 SOLAR-READY ZONE

APPENDIX CC-Reserved

ZERO ENERGY COMMERCIAL BUILDING PROVISIONS

The provisions contained in this appendix are not mandatory, unless specifically referenced in the adopting ordinance.

User note:

— About this chapter: Appendix CC provides a model for applying new renewable energy generation when new buildings add electric load to the grid. This renewable energy will avoid the additional emissions that would otherwise occur from conventional power generation.

SECTION CC101 GENERAL

CC101.1 Purpose. The purpose of this appendix is to supplement the *International Energy Conservation Code* and require renewable energy systems of adequate capacity to achieve net zero carbon.

CC101.2 Scope. This appendix applies to new buildings that are addressed by the *International Energy Conservation Code*.

Exceptions:

1. ~~Detached one- and two-family dwellings and townhouses as well as Group R-2 buildings three stories or less in height above grade plane, manufactured homes (mobile dwellings), and manufactured houses (modular dwellings).~~
2. ~~Buildings that use neither electricity nor fossil fuel.~~

SECTION CC102 DEFINITIONS

CC102.1 Definitions. The definitions contained in this section supplement or modify the definitions in the *International Energy Conservation Code*.

ADJUSTED OFF-SITE RENEWABLE ENERGY. ~~The amount of energy production from off-site renewable energy systems that may be used to offset building energy.~~

BUILDING ENERGY. ~~All energy consumed at the *building site* as measured at the site boundary. Contributions from on-site or off-site renewable energy systems shall not be considered when determining the building energy.~~

~~ENERGY UTILIZATION INTENSITY (EUI).~~ ~~_____ conditioned floor area _____~~

OFF-SITE RENEWABLE ENERGY SYSTEM. ~~Renewable energy system not located on the building project.~~

ON-SITE RENEWABLE ENERGY SYSTEM. ~~Renewable energy systems on the building project.~~

RENEWABLE ENERGY SYSTEM. ~~Photovoltaic, solar thermal, geothermal energy and wind systems used to generate energy.~~

~~SEMIHEATED SPACE.~~ ~~_____ ² _____~~

ZERO ENERGY PERFORMANCE INDEX (ZEPI PB/EE). ~~The ratio of the proposed building EUI without renewables to the baseline building EUI, expressed as a percentage.~~

SECTION CC103 MINIMUM RENEWABLE ENERGY

CC103.1 Renewable energy. On-site renewable energy systems shall be installed, or off-site renewable energy shall be procured to offset the building energy as calculated in Equation CC-1.

$$RE_{\text{on-site}} + RE_{\text{off-site}} \geq E_{\text{building}} \quad (\text{Equation CC-1})$$

where:

RE_{onsite} = Annual site energy production from on-site renewable energy systems (see Section CC103.2).

$RE_{offsite}$ = Adjusted annual site energy production from off-site renewable energy systems that may be credited against building energy use (see Section CC103.3).

$E_{building}$ = Building energy use without consideration of renewable energy systems.

When Section C401.2.1(1) is used for compliance with the *International Energy Conservation Code*, building energy shall be determined by multiplying the gross conditioned floor area plus the gross semiheated floor area of the proposed building by an EUI selected from Table CC103.1. Use a weighted average for mixed-use buildings.

When Section C401.2.1, Item 2 or Section C401.2.2 is used for compliance with the *International Energy Conservation Code*, building energy shall be determined from energy simulations.

TABLE CC103.1

ENERGY UTILIZATION INTENSITY FOR BUILDING TYPES AND CLIMATES (kBtu/ft²-yr)

BUILDING AREA TYPE	CLIMATE ZONE																
	0A/1A	0B/1B	2A	2B	3A	3B	3C	4A	4B	4C	5A	5B	5C	6A	6B	7	8
	kBtu/ft ² -yr																
Healthcare/hospital (I-2)	119	120	119	113	116	109	106	116	109	106	118	110	105	126	116	131	142
Hotel/motel (R-1)	73	76	73	68	70	67	65	69	66	65	71	68	65	77	72	81	89
Multiple-family (R-2)	43	45	41	41	43	42	36	45	43	41	47	46	41	53	48	53	59
Office (B)	31	32	30	29	29	28	25	28	27	25	29	28	25	33	30	32	36
Restaurant (A-2)	389	426	411	408	444	420	395	483	437	457	531	484	484	589	538	644	750
Retail (M)	46	50	45	46	44	44	37	48	44	44	52	50	46	60	52	64	77
School (E)	42	46	42	40	40	39	36	39	40	40	39	43	37	44	40	45	54
Warehouse (S)	9	12	9	11	12	11	10	17	13	14	23	17	15	32	23	32	32
All others	55	58	54	53	53	51	48	54	52	51	57	54	50	63	57	65	73

CC103.2 Calculation of on-site renewable energy. The annual energy production from on-site renewable energy systems shall be determined using the PVWatts software or other software approved by the code official.

CC103.3 Off-site renewable energy. Off-site energy shall comply with Sections CC103.3.1 and CC103.3.2.

CC103.3.1 Qualifying off-site procurement methods. The following are considered qualifying off-site renewable energy procurement methods:-

1. Community renewables: an off-site renewable energy system for which the owner has purchased or leased renewable energy capacity along with other subscribers.
2. Renewable energy investment fund: an entity that installs renewable energy capacity on behalf of the owner.
3. Virtual power purchase agreement: a power purchase agreement for off-site renewable energy where the owner agrees to purchase renewable energy output at a fixed price schedule.
4. Direct ownership: an off-site renewable energy system owned by the building project owner.

- 5. ~~Direct access to wholesale market: an agreement between the owner and a renewable energy developer to purchase renewable energy.~~
- 6. ~~Green retail tariffs: a program by the retail electricity provider to provide 100-percent renewable energy to the owner.~~
- 7. ~~Unbundled Renewable Energy Certificates (RECs): certificates purchased by the owner representing the environmental benefits of renewable energy generation that are sold separately from the electric power.~~

CC103.3.2 Requirements for all procurement methods. The following requirements shall apply to all *off-site renewable energy* procurement methods:

- 1. ~~The building owner shall sign a legally binding contract to procure qualifying off-site renewable energy.~~
- 2. ~~The procurement contract shall have duration of not less than 15 years and shall be structured to survive a partial or full transfer of ownership of the property.~~
- 3. ~~RECs and other environmental attributes associated with the procured off-site renewable energy shall be assigned to the building project for the duration of the contract.~~
- 4. ~~The renewable energy generating source shall include one or more of the following: photovoltaic systems, solar thermal power plants, geothermal power plants and wind turbines.~~
- 5. ~~The generation source shall be located where the energy can be delivered to the building site by the same utility or distribution entity, the same independent system operator (ISO) or regional transmission organization (RTO), or within integrated ISOs (electric coordination council).~~
- 6. ~~The off-site renewable energy producer shall maintain transparent accounting that clearly assigns production to the building. Records on power sent to or purchased by the building shall be retained by the building owner and made available for inspection by the code official upon request.~~

CC103.3.3 Adjusted off-site renewable energy. The process for calculating the adjusted *off-site renewable energy* is shown in Equation CC-2.

$$RE_{offsite} = \sum_{i=1}^n PF_i \times RE_i - PF_1 \times RE_1 + PF_2 \times RE_2 + \dots - PF_n \times RE_n$$

(Equation CC-2)

~~$RE_{offsite}$ — Adjusted off site renewable energy.~~

~~PF_i — Procurement factor for the i^{th} renewable energy procurement method or class taken from Table CC103.3.3.~~

~~RE_i — Annual energy production for the i^{th} renewable energy procurement method or class.~~

~~n — The number of renewable energy procurement options or classes considered.~~

CLASS	PROCUREMENT FACTOR (PF)	PROCUREMENT OPTIONS	ADDITIONAL REQUIREMENTS (see also Section CC103.3.2)
1	0.75	Community solar	—
		REIFs	Entity must be managed to prevent fraud or misuse of funds.
		Virtual PPA	—

		Self-owned off-site	Provisions shall prevent the generation from being sold separately from the building.
2	0.55	Green retail tariffs	The offering shall not include the purchase of unbundled RECs.
		Direct access	The offering shall not include the purchase of unbundled RECs.
3	0.20	Unbundled RECs	The vintage of the RECs shall align with building energy use.

IECC—RESIDENTIAL PROVISIONS

TABLE OF CONTENTS

APPENDIX R1 RESIDENTIAL REQUIREMENTS. R-37

APPENDIX R2 FOAM PLASTIC DIAGRAMS . . . R-57

APPENDIX R3 SAMPLE WORKSHEETS FOR RESIDENTIAL AIR AND DUCT LEAKAGE TESTING R-61

APPENDIX R4 ADDITIONAL VOLUNTARY CRITERIA FOR INCREASING ENERGY EFFICIENCY (High-Efficiency Residential Option) R-65

CHAPTER 1 [RE] SCOPE AND ADMINISTRATION

User note:

- **About this chapter:** Chapter 1 establishes the limits of applicability of this code and describes how the code is to be applied and enforced. Chapter 1 is in two parts: Part 1—Scope and Application (Sections R101–R102) and Part 2—Administration and Enforcement (Sections R103–R110). Section R101 identifies which buildings and structures come under its purview and references other I-Codes as applicable. Standards and codes are scoped to the extent referenced (see Section R108.1).
- This code is intended to be adopted as a legally enforceable document, and it cannot be effective without adequate provisions for its administration and enforcement. The provisions of Chapter 1 establish the authority and duties of the code official appointed by the authority having jurisdiction and also establish the rights and privileges of the design professional, contractor and property owner.

PART 1—SCOPE AND APPLICATION

SECTION R101 SCOPE AND GENERAL REQUIREMENTS

R101.1 Title. This code shall be known as the *Energy Conservation Code* of [NAME OF JURISDICTION] and shall be cited as such. It is referred to herein as “this code.” This code shall be known as the *North Carolina Energy Conservation Code* as adopted by the North Carolina Building Code Council on XXXX XX 2022 to be effective January 1, 2025. References to the *International Codes* shall mean the *North Carolina Codes*. The NCECC is referred to herein as “the code”.

101.6 Requirements of other State agencies, occupational licensing board or commissions. -see the NC Administrative Code and Policies

SECTION R102 ALTERNATIVE MATERIALS, DESIGN AND METHODS OF CONSTRUCTION AND EQUIPMENT

PART 2—ADMINISTRATION AND ENFORCEMENT

SECTION R103 CONSTRUCTION DOCUMENTS

R103.1 General. Construction documents, technical reports and other supporting data shall be submitted in one or more sets, or in a digital format where allowed by the *code official*, with each application for a permit. The construction documents and technical reports shall be prepared by a registered design professional where required by the statutes of the jurisdiction in which the project is to be constructed. Where special conditions exist, the *code official* is authorized to require necessary construction documents to be prepared by a registered design professional.

Exceptions:

1. The *code official* is authorized to waive the requirements for construction documents or other supporting data if the *code official* determines they are not necessary to confirm compliance with this code.
2. Refer to NCGS 160D-1110 (b) for statutory limitations on requirements for one-and-two family dwellings and town-houses plans.

R103.3 Examination of documents. ~~The *code official* shall examine or cause to be examined the accompanying construction documents and shall ascertain whether the construction indicated and described is in accordance with the requirements of this code and other pertinent laws or ordinances. The *code official* is authorized to utilize a registered design professional, or other *approved* entity not affiliated with the building design or construction, in conducting the review of the plans and specifications for compliance with the code. Deleted. See the *North Carolina Administrative Code and Policies*.~~

R103.3.1 Approval of construction documents. ~~Deleted. When the *code official* issues a permit where construction documents are required, the construction documents shall be endorsed in writing and stamped “Reviewed for Code Compliance.” Such *approved* construction documents shall not be changed, modified or altered without authorization from the *code official*. Work shall be done in accordance with the *approved* construction documents.~~

One set of construction documents so reviewed shall be retained by the *code official*. The other set shall be returned to the applicant, kept at the site of work and shall be open to inspection by the *code official* or a duly authorized representative.

R103.3.2 Previous approvals. ~~This code shall not require changes in the construction documents, construction or designated occupancy of a structure for which a lawful permit has been heretofore issued or otherwise lawfully authorized, and the construction of which has been pursued in good faith within 180 days after the effective date of this code and has not been abandoned. Deleted.~~

R103.3.3 Phased approval. ~~The *code official* shall have the authority to issue a permit for the construction of part of an energy conservation system before the construction documents for the entire system have been submitted or *approved*, provided adequate information and detailed statements have been filed complying with all pertinent requirements of this code. The holders of such permit shall proceed at their own risk without assurance that the permit for the entire energy conservation system will be granted. Deleted.~~

R103.4 Amended construction documents. ~~Work shall be installed in accordance with the *approved* construction documents, and any changes made during construction that are not in compliance with the *approved* construction documents shall be resubmitted for approval as an amended set of construction documents. Deleted. See the *North Carolina Administrative Code and Policies*.~~

R103.5 Retention of construction documents. ~~One set of *approved* construction documents shall be retained by the *code official* for a period of not less than 180 days from date of completion of the permitted work, or as required by state or local laws. Deleted. See the *North Carolina Administrative Code and Policies*.~~

SECTION R104 FEES

~~Deleted. See the *North Carolina Administrative Code and Policies*.~~

R104.1 Fees. A permit shall not be issued until the fees prescribed in Section R104.2 have been paid, nor shall an amendment to a permit be released until the additional fee, if any, has been paid.

R104.2 Schedule of permit fees. Where a permit is required, a fee for each permit shall be paid as required, in accordance with the schedule as established by the applicable governing authority.

R104.3 Work commencing before permit issuance. Any person who commences any work before obtaining the necessary permits shall be subject to an additional fee established by the *code official* that shall be in addition to the required permit fees.

R104.4 Related fees. The payment of the fee for the construction, *alteration*, removal or demolition of work done in connection to or concurrently with the work or activity authorized by a permit shall not relieve the applicant or holder of the permit from the payment of other fees that are prescribed by law.

R104.5 Refunds. The *code official* is authorized to establish a refund policy.

SECTION R105 INSPECTIONS

Deleted. See the North Carolina Administrative Code and Policies.

R105.1 General. Construction or work for which a permit is required shall be subject to inspection by the *code official* or his or her designated agent, and such construction or work shall remain visible and able to be accessed for inspection purposes until *approved*. It shall be the duty of the permit applicant to cause the work to remain visible and able to be accessed for inspection purposes. Neither the *code official* nor the jurisdiction shall be liable for expense entailed in the removal or replacement of any material, product, system or building component required to allow inspection to validate compliance with this code.

R105.2 Required inspections. The *code official* or his or her designated agent, upon notification, shall make the inspections set forth in Sections R105.2.1 through R105.2.5.

R105.2.1 Footing and foundation inspection. Inspections associated with footings and foundations shall verify compliance with the code as to *R value*, location, thickness, depth of burial and protection of insulation as required by the code and *approved* plans and specifications.

R105.2.2 Framing and rough-in inspection. Inspections at framing and rough-in shall be made before application of interior finish and shall verify compliance with the code as to: types of insulation and corresponding *R values* and their correct location and proper installation; fenestration properties such as *U* factor and SHGC and proper installation; air leakage controls as required by the code; and *approved* plans and specifications.

R105.2.3 Plumbing rough-in inspection. Inspections at plumbing rough-in shall verify compliance as required by the code and *approved* plans and specifications as to types of insulation and corresponding *R values* and protection, and required controls.

R105.2.4 Mechanical rough-in inspection. Inspections at mechanical rough-in shall verify compliance as required by the code and *approved* plans and specifications as to installed HVAC equipment type and size, required controls, system insulation and corresponding *R value*, system air leakage control, programmable thermostats, dampers, whole house ventilation, and minimum fan efficiency.

Exception: Systems serving multiple dwelling units shall be inspected in accordance with Section C105.2.4.

R105.2.5 Final inspection. The *building* shall have a final inspection and shall not be occupied until *approved*. The final inspection shall include verification of the installation of all required *building* systems, equipment and controls and their proper operation and the required number of high efficacy lamps and fixtures.

R105.3 Reinspection. A *building* shall be reinspected where determined necessary by the *code official*.

R105.4 Approved inspection agencies. The *code official* is authorized to accept reports of third party inspection agencies not affiliated with the *building* design or construction, provided that such agencies are *approved* as to qualifications and reliability relevant to the *building* components and systems that they are inspecting.

~~**R105.5 Inspection requests.** It shall be the duty of the holder of the permit or their duly authorized agent to notify the *code official* when work is ready for inspection. It shall be the duty of the permit holder to provide access to and means for inspections of such work that are required by this code.~~

~~**R105.6 Reinspection and testing.** Where any work or installation does not pass an initial test or inspection, the necessary corrections shall be made to achieve compliance with this code. The work or installation shall then be resubmitted to the *code official* for inspection and testing.~~

SECTION R106 NOTICE OF APPROVAL

~~Deleted. See the *North Carolina Administrative Code and Policies*.~~

~~**R106.1 Approval.** After the prescribed tests and inspections indicate that the work complies in all respects with this code, a notice of approval shall be issued by the *code official*.~~

~~**R106.2 Revocation.** The *code official* is authorized to, in writing, suspend or revoke a notice of approval issued under the provisions of this code wherever the certificate is issued in error, or on the basis of incorrect information supplied, or where it is determined that the *building* or structure, premise, or portion thereof is in violation of any ordinance or regulation or any of the provisions of this code.~~

SECTION R107 VALIDITY

~~Deleted. See the *North Carolina Administrative Code and Policies*.~~

~~**R107.1 General.** If a portion of this code is held to be illegal or void, such a decision shall not affect the validity of the remainder of this code.~~

SECTION R108 REFERENCED STANDARDS

SECTION R109 STOP WORK ORDER

~~**R109.1 Authority.** Deleted. See the *North Carolina Administrative Code and Policies*.~~

~~Where the *code official* finds any work regulated by this code being performed in a manner contrary to the provisions of this code or in a dangerous or unsafe manner, the *code official* is authorized to issue a stop work order.~~

~~**R109.2 Issuance.** The stop work order shall be in writing and shall be given to the owner of the property, the owner's authorized agent or the person performing the work. Upon issuance of a stop work order, the cited work shall immediately cease. The stop work order shall state the reason for the order and the conditions under which the cited work is authorized to resume.~~

~~**R109.3 Emergencies.** Where an emergency exists, the *code official* shall not be required to give a written notice prior to stopping the work.~~

~~**R109.4 Failure to comply.** Any person who shall continue any work after having been served with a stop work order, except such work as that person is directed to perform to remove a violation or unsafe condition, shall be subject to fines established by the authority having jurisdiction.~~

SECTION R110 MEANS OF APPEALS

~~Deleted. See the *North Carolina Administrative Code and Policies*.~~

~~**R110.1 General.** In order to hear and decide appeals of orders, decisions or determinations made by the *code official* relative to the application and interpretation of this code, there shall be and is hereby created a board of appeals. The board of appeals shall~~

be appointed by the applicable governing authority and shall hold office at its pleasure. The board shall adopt rules of procedure for conducting its business and shall render all decisions and findings in writing to the appellant with a duplicate copy to the code official.

R110.2 Limitations on authority. ~~An application for appeal shall be based on a claim that the true intent of this code or the rules legally adopted thereunder have been incorrectly interpreted, the provisions of this code do not fully apply or an equivalent or better form of construction is proposed. The board shall not have authority to waive requirements of this code or interpret the administration of this code.~~

R110.3 Qualifications. ~~The board of appeals shall consist of members who are qualified by experience and training and are not employees of the jurisdiction.~~

R110.4 Administration. ~~The code official shall take immediate action in accordance with the decision of the board.~~

CHAPTER 2 [RE] DEFINITIONS

User note:

About this chapter: Codes, by their very nature, are technical documents. Every word, term and punctuation mark can add to or change the meaning of a technical requirement. It is necessary to maintain a consensus on the specific meaning of each term contained in the code. Chapter 2 performs this function by stating clearly what specific terms mean for the purpose of the code.

SECTION R201 GENERAL

SECTION R202 GENERAL DEFINITIONS

ACH50. Air changes per hour of measured air flow in relation to the building volume while the building is maintained at a pressure difference of 50 Pascals.

AIR BARRIER MATERIAL. Material(s) that have an air permeability not to exceed 0.004 cfm/ft² under a pressure differential of 0.3 in. water (1.57psf) (0.02 L/s.m² @ 75 Pa) when tested in accordance with ASTM E2178.

AIR BARRIER SYSTEM. Material(s) assembled and joined together to provide a barrier to air leakage through the building envelope. An air barrier system is a combination of air barrier materials and sealants.

CLOSED CRAWL SPACE. A foundation without wall vents that uses air sealed walls, ground and foundation moisture control, and mechanical drying potential to control crawl space moisture. Insulation may be located at the floor level or at the exterior walls

FENESTRATION PRODUCT, FIELD-FABRICATED. A fenestration product whose frame is made at the construction site of standard dimensional lumber or other materials that were not previously cut, or otherwise formed with the specific intention of being used to fabricate a fenestration product or exterior door. Field fabricated does not include site-built fenestration.

HERS RATER. An individual that has completed training and been certified by RESNET (Residential Energy Services Network) Accredited Rating Provider and has a current certification.

LABELED. Appliances, equipment, ~~Equipment~~, materials or products to which have been affixed a label, seal, symbol or other identifying mark of a nationally recognized testing laboratory, *approved* agency or other organization concerned with product evaluation that maintains periodic inspection of the production of such labeled items and whose labeling indicates either that the appliances, equipment, material or product meets identified standards or has been tested and found suitable for a specified purpose.

LISTED. Appliances, ~~Equipment~~, materials, products or services included in a list published by an organization acceptable to the *code official* and concerned with evaluation of products or services that maintains periodic inspection of production of *listed appliances, equipment or materials* or periodic evaluation of services and whose listing states either that the equipment, material, product or service meets identified standards or has been tested and found suitable for a specified purpose.

REGISTERED DESIGN PROFESSIONAL. An individual who is registered or licensed to practice their respective design profession as defined by the statutory requirements of the professional registration laws of the state or jurisdiction in which the project is to be constructed. Design by a registered design professional is not required where exempt under the registration or licensure laws.

SITE-RECOVERED ENERGY. Waste energy recovered at the building site that is used to off-set consumption of purchased fuel or electrical energy supplies.

CHAPTER 3 [RE] GENERAL REQUIREMENTS

User note:

— **About this chapter:** Chapter 3 addresses broadly applicable requirements that would not be at home in other chapters having more specific coverage of subject matter. This chapter establishes climate zone by US counties and territories and includes methodology for determining climate zones elsewhere. It also contains product rating, marking and installation requirements for materials such as insulation, windows, doors and siding.

SECTION R301 CLIMATE ZONES

R301.1 General. *Climate zones* from Figure R301.1 or Table R301.1 shall be used for determining the applicable requirements from Chapter 4. Locations not indicated in Table R301.1 shall be assigned a *climate zone* in accordance with Section R301.3.

R301.2 Warm Humid counties. In Table R301.1, Warm Humid counties are identified by an asterisk.

Note to Editor: All states and provinces to be removed except for NC

TABLE R301.1

NORTH CAROLINA CLIMATE ZONES, MOISTURE REGIMES, AND WARM-HUMID DESIGNATIONS BY COUNTY CLIMATE ZONES, MOISTURE REGIMES, AND WARM HUMID DESIGNATIONS BY STATE, COUNTY AND TERRITORY^a

a. Key: A – Moist, B – Dry, C – Marine. Absence of moisture designation indicates moisture regime is irrelevant. Asterisk (*) indicates a Warm Humid location.

US STATES
NORTH CAROLINA
3A Alamance
3A Alexander
5A Alleghany
3A Anson
5A Ashe
5A Avery
3A Beaufort
3A Bertie
3A Bladen
3A Brunswick*
4A Buncombe
4A Burke
3A Cabarrus
4A Caldwell
3A Camden
3A Carteret*
3A Caswell

3A Catawba
3A Chatham
3A Cherokee
3A Chowan
3A Clay
3A Cleveland
3A Columbus*
3A Craven
3A Cumberland
3A Currituck
3A Dare
3A Davidson
3A Davie
3A Duplin
3A Durham
3A Edgecombe
3A Forsyth
3A Franklin
3A Gaston
3A Gates
4A Graham
3A Granville
3A Greene
3A Guilford
3A Halifax
US STATES continued
NORTH CAROLINA (continued)
3A Harnett
4A Haywood
4A Henderson
3A Hertford
3A Hoke
3A Hyde
3A Iredell
4A Jackson

3A Johnston
3A Jones
3A Lee
3A Lenoir
3A Lincoln
4A Macon
4A Madison
3A Martin
4A McDowell
3A Mecklenburg
4A Mitchell
3A Montgomery
3A Moore
3A Nash
3A New Hanover*
3A Northampton
3A Onslow*
3A Orange
3A Pamlico
3A Pasquotank
3A Pender*
3A Perquimans
3A Person
3A Pitt
3A Polk
3A Randolph
3A Richmond
3A Robeson
3A Rockingham
3A Rowan
3A Rutherford
3A Sampson
3A Scotland
3A Stanly

4A Stokes
4A Surry
4A Swain
4A Transylvania
3A Tyrrell
3A Union
3A Vance
3A Wake
3A Warren
3A Washington
5A Watauga
3A Wayne
3A 4A Wilkes
3A Wilson
4A Yadkin
5A Yancey

R301.4 Tropical climate region. ~~The tropical region shall be defined as:~~ Deleted.

- ~~1. Hawaii, Puerto Rico, Guam, American Samoa, U.S. Virgin Islands, Commonwealth of Northern Mariana Islands; and~~
- ~~2. Islands in the area between the Tropic of Cancer and the Tropic of Capricorn.~~

**SECTION R302
DESIGN CONDITIONS**

**SECTION R303
MATERIALS, SYSTEMS AND EQUIPMENT**

R303.3 Maintenance information. ~~Operations and M~~aintenance instructions ~~and manuals~~ shall be furnished for equipment and systems that require preventive maintenance. ~~Required regular maintenance actions shall be clearly stated and incorporated on a readily visible label. The label shall include the title or publication number for the operation and maintenance manual for that particular model and type of product.~~

CHAPTER 4 [RE] RESIDENTIAL ENERGY EFFICIENCY

User note:

~~— **About this chapter:** Chapter 4 presents the paths and options for compliance with the energy efficiency provisions. Chapter 4 contains energy efficiency provisions for the building envelope, mechanical and water heating systems, lighting and additional efficiency requirements. A performance alternative, and energy rating alternative., and tropical regional alternative are also provided to allow for energy code compliance other than by the prescriptive method.~~

SECTION R401 GENERAL

R401.2 Application. Residential buildings shall comply with Section R401.2.5 and either Sections R401.2.1, R401.2.2, or R401.2.3 ~~or R401.2.4.~~

Exception: Additions, *alterations*, repairs and changes of occupancy to existing buildings complying with Chapter 5.

R401.2.4 Tropical Climate Region Option. ~~Deleted. The Tropical Climate Region Option requires compliance with Section R407.~~

R401.3 Certificate. A permanent certificate shall be completed by the builder, permit holder, registered design professional or other approved party . ~~and posted on a wall in the space where the furnace is located, a utility room or an approved~~ The permanent certificate shall be posted in a readily accessible location on the electrical distribution panel, in the attic next to the attic insulation card, in a utility room or other approved location inside the *building*. Where located on an electrical panel, the certificate shall not cover or obstruct the visibility of the circuit directory *label*, service disconnect *label* or other required labels. The certificate shall indicate the following:

1. The predominant *R*-values of insulation installed in or on ceilings, roofs, walls, foundation components such as slabs, *basement walls, crawl space walls* and floors and ducts outside *conditioned spaces*.
2. *U*-factors of fenestration and the *solar heat gain coefficient* (SHGC) of fenestration. Where there is more than one value for any component of the building envelope, the certificate shall indicate both the value covering the largest area and the area weighted average value if available.
3. The results from any required duct system and building envelope air leakage testing performed on the building.
4. The types, sizes and efficiencies of heating, cooling and service water-heating equipment. Where a gas-fired unvented room heater, electric furnace or baseboard electric heater is installed in the residence, the certificate shall indicate “gas-fired unvented room heater,” “electric furnace” or “baseboard electric heater,” as appropriate. An efficiency shall not be indicated for gas-fired unvented room heaters, electric furnaces and electric baseboard heaters.
5. Where on-site *photovoltaic panel* systems have been installed, the array capacity, inverter efficiency, panel tilt and orientation shall be noted on the certificate.
6. For buildings where an Energy Rating Index score is determined in accordance with Section R406, the Energy Rating Index score, both with and without any on-site generation, shall be listed on the certificate.
7. The code edition under which the structure was permitted, and the compliance path used.

R401.4 Additional voluntary criteria for increasing residential energy efficiency. Not Used. Reserved for future use.

SECTION R402 BUILDING THERMAL ENVELOPE

R402.1 General. The *building thermal envelope* shall comply with the requirements of Sections R402.1.1 through R402.1.5.

Exceptions:

1. The following low-energy *buildings*, or portions thereof, separated from the remainder of the building by *building thermal envelope* assemblies complying with this section shall be exempt from the *building thermal envelope* provisions of Section R402.
 - 1.1. Those with a peak design rate of energy usage less than 3.4 Btu/h × ft² (10.7 W/m²) or 1.0 watt/ft² of floor area for space-conditioning purposes.
 - 1.2. Those that do not contain *conditioned space*.
2. Log homes designed in accordance with ICC 400.

**TABLE R402.1.2
MAXIMUM ASSEMBLY U-FACTORS^a AND FENESTRATION REQUIREMENTS**

CLIMATE ZONE	FENESTRATION U-FACTOR ^f	SKYLIGHT U-FACTOR	GLAZED FENESTRATION SHGC ^{d, e}	CEILING U-FACTOR ^a	WOOD FRAME WALL U-FACTOR	MASS WALL U-FACTOR ^b	FLOOR U-FACTOR	BASEMENT WALL U-FACTOR	CRAWL SPACE WALL U-FACTOR
0	0.50	0.75	0.25	0.035	0.084	0.197	0.064	0.360	0.477
1	0.50	0.75	0.25	0.035	0.084	0.197	0.064	0.360	0.477
2	0.40	0.65	0.25	0.026	0.084	0.165	0.064	0.360	0.477
3	0.30	0.55	0.25	0.026	0.060	0.098	0.047	0.091 ^c	0.136
4 except Marine	0.30	0.55	0.40	0.024	0.045	0.098	0.047	0.059	0.065
5 and Marine 4	0.30	0.55	NR	0.024	0.045	0.082	0.033	0.050	0.055
6	0.30	0.55	NR	0.024	0.045	0.060	0.033	0.050	0.055
7 and 8	0.30	0.55	NR	0.024	0.045	0.057	0.028	0.050	0.055

For SI: 1 foot = 304.8 mm.

- a. Nonfenestration *U*-factors shall be obtained from measurement, calculation or an approved source.
- b. Mass walls shall be in accordance with Section R402.2.5. Where more than half the insulation is on the interior, the mass wall *U*-factors shall not exceed 0.17 in Climate Zones 0 and 1, 0.14 in Climate Zone 2, 0.12 in Climate Zone 3, 0.087 in Climate Zone 4 except Marine, 0.065 in Climate Zone 5 and Marine 4, and 0.057 in Climate Zones 6 through 8.
- c. In Warm Humid locations as defined by Figure R301.1 and Table R301.1, the basement wall *U*-factor shall not exceed 0.360.
- d. The SHGC column applies to all glazed fenestration.
Exception: In Climate Zones 0 through 3, skylights shall be permitted to be excluded from glazed fenestration SHGC requirements provided that the SHGC for such skylights does not exceed 0.30.
- e. ~~There are no SHGC requirements in the Marine Zone. Deleted.~~
- f. A maximum *U*-factor of 0.32 shall apply in Marine Climate Zone 4 and Climate Zones 5 Zone 5 through 8 to vertical fenestration products installed in buildings located either:
 1. Above 4,000 feet in elevation above sea level, or
 2. In windborne debris regions where protection of openings is required by Section R301.2.1.2 of the *International Residential Code*.
- g. Roofs insulated at the deck (above, below, or combination) shall meet the U-factors for the climate zone of the building location.

**TABLE R402.1.3
INSULATION MINIMUM R-VALUES AND FENESTRATION REQUIREMENTS BY COMPONENT^a**

CLIMATE ZONE	FENESTRATION U-FACTOR ^{b, i}	SKYLIGHT ^b U-FACTOR	GLAZED FENESTRATION SHGC ^{b, e}	CEILING R-VALUE ⁱ	WOOD FRAME WALL R-VALUE ^g	MASS WALL R-VALUE ^h	FLOOR R-VALUE	BASEMENT ^{c, g} WALL R-VALUE	SLAB ^d R-VALUE & DEPTH	CRAWL SPACE ^{c, g} WALL R-VALUE
0	NR	0.75	0.25	30	13 or 0 + 10	3/4	13	0	0	0

1	NR	0.75	0.25	30	13 or 0 + 10	3/4	13	0	0	0
2	0.40	0.65	0.25	49	13 or 0 + 10	4/6	13	0	0	0
3	.30	0.55	0.25	49	20 or 13 + 5ci or 0 + 15	8/13	19	5ci or 13 ^f	10ci, 2 ft	5ci or 13 ^f
4 except Marine	.30	0.55	0.40	60	20 + 5 or 13 + 10ci or 0 + 15	8/13	19	10ci or 13	10ci, 4 ft	10ci or 13
5 and Marine 4	0.30 ⁱ	0.55	0.40	60	20 + 5 or 13 + 10ci or 0 + 15	13/17	30	15ci or 19 or 13 + 5ci	10ci, 4 ft	15ci or 19 or 13 + 5ci
6	0.30 ⁱ	0.55	NR	60	20 + 5ci or 13 + 10ci or 0 + 20	15/20	30	15ci or 19 or 13 + 5ci	10ci, 4 ft	15ci or 19 or 13 + 5ci
7 and 8	0.30 ⁱ	0.55	NR	60	20 + 5ci or 13 + 10ci or 0 + 20	19/21	38	15ci or 19 or 13 + 5ci	10ci, 4 ft	15ci or 19 or 13 + 5ci

For SI: 1 foot = 304.8 mm.

NR = Not Required.

ci = continuous insulation.

i. A maximum *U*-factor of 0.32 shall apply in Climate Zones 3 through 8 Zone 5 to vertical fenestration products installed in buildings located either:

1. Above 4,000 feet in elevation, or
2. In windborne debris regions where protection of openings is required by Section R301.2.1.2 of the *International Residential Code*.

j. Roofs insulated at the deck (above, below, or combination) shall meet the U-factors in Table R402.1.2.

R402.1.5 Total UA alternative. Where the total *building thermal envelope* UA, the sum of *U*-factor times assembly area, is less than or equal to the total UA resulting from multiplying the *U*-factors in Table R402.1.2 by the same assembly area as in the proposed *building*, the *building* shall be considered to be in compliance with Table R402.1.2. The UA calculation shall be performed using a method consistent with the ASHRAE *Handbook of Fundamentals* and shall include the thermal bridging effects of framing materials. In addition to UA compliance, the SHGC requirements of Table R402.1.2 and the maximum fenestration *U*-factors of Section R402.5 shall be met.

REScheck Option. North Carolina approved version of REScheck shall be permitted to demonstrate compliance with this code. Envelope requirements may not be traded off against the use of high efficiency heating or cooling equipment. No tradeoff calculations are needed for required termite inspection and treatment gaps.

R402.1.6 Rooms containing fuel-burning appliances. In Climate Zones 3 through 8-5, where open combustion air ducts provide combustion air to open combustion fuel burning appliances, the appliances and combustion air opening shall be located outside the building thermal envelope or enclosed in a room that is isolated from inside the thermal envelope. Such rooms shall be sealed and insulated in accordance with the envelope requirements of Table R402.1.3, where the walls, floors and ceilings shall meet a minimum of the basement wall R-value requirement. The door into the room shall be fully gasketed and any water lines and ducts in the room insulated in accordance with Section R403. The combustion air duct shall be insulated where it passes through conditioned space to an R-value of not less than R-8.

Exceptions:

1. Direct vent appliances with both intake and exhaust pipes installed continuous to the outside.
2. Fireplaces and stoves complying with Section R402.4.2 and Section R1006 of the *International Residential Code*.

R402.2.1 Ceilings with attic spaces. Where Section R402.1.3 requires R-49 insulation in the ceiling or attic, installing R-38 over 100 percent of the ceiling or attic area requiring insulation shall satisfy the requirement for R-49 insulation wherever the full height of uncompressed R-38 insulation extends over the wall top plate at the eaves. Where Section R402.1.3 requires R-60 insulation in the ceiling, installing R-49 over 100 percent of the ceiling area requiring insulation shall satisfy the requirement for R-60 insulation wherever the full height of uncompressed R-49 insulation extends over the wall top plate at the eaves. This reduction shall not apply to the insulation and fenestration criteria in Section R402.1.2 and the Total UA alternative in Section R402.1.5.

Exception. In other details such as bay window and dormer roofs, and similar areas where the space is limited, the available space shall be filled with insulation for unvented details, and to the insulation baffle for vented assemblies.

R402.2.2 Ceilings without attics. Where Section R402.1.3 requires insulation *R*-values greater than R-30 in the interstitial space above a ceiling and below the structural roof deck, and the design of the roof/ceiling assembly including cathedral ceilings, dormers, bay windows and other similar areas, does not allow sufficient space for the required insulation, the minimum required insulation *R*-value for such roof/ceiling assemblies shall be R-30. Insulation shall extend over the top of the wall plate to the outer edge of such plate and shall not be compressed. This reduction of insulation from the requirements of Section R402.1.3 shall be limited to 500 square feet (46 m²) or 20 percent of the total insulated ceiling area, whichever is less. This reduction shall not apply to the Total UA alternative in Section R402.1.5.

R402.2.3 Eave Soffit baffle. For air-permeable insulation in vented attics, a baffle shall be installed adjacent to soffit and eave vents. Baffles shall maintain a net free area opening equal to or greater than the size of the vent. The baffle shall extend over the top of the attic insulation. The baffle shall be permitted to be any solid material. The baffle shall be installed to the outer edge of the *exterior wall* top plate so as to provide maximum space for attic insulation coverage over the top plate. Where soffit venting is not continuous, baffles shall be installed continuously to prevent ventilation air in the eave/soffit from bypassing the baffle.

R402.2.4 Access hatches and doors. Access hatches and doors from conditioned to unconditioned spaces such as attics and crawl spaces shall be insulated to the same *R*-value required by Table R402.1.3 for the wall or ceiling in which they are installed.

Exceptions:

1. Vertical doors providing access from conditioned spaces to unconditioned spaces that comply with the fenestration requirements of Table R402.1.3 based on the applicable climate zone specified in Chapter 3.
2. Horizontal pull-down, stair-type access hatches in ceiling assemblies that provide access from conditioned to unconditioned spaces in Climate Zones ~~0 through 4~~ 3, 4, & 5 shall not be required to comply with the insulation level of the surrounding surfaces provided the hatch meets all of the following:
 - 2.1. The average *U*-factor of the hatch shall be less than or equal to U-0.10 or have an average insulation *R*-value of R-10 or greater.
 - 2.2. Not less than 75 percent of the panel area shall have an insulation *R*-value of R-13 or greater.
 - 2.3. The net area of the framed opening shall be less than or equal to 13.5 square feet (1.25 m²).
 - 2.4. The perimeter of the hatch edge shall be weatherstripped.

The reduction shall not apply to the total UA alternative in Section R402.1.5.

R402.2.5 Mass walls. Mass walls for the purposes of this chapter shall be considered walls of concrete block, concrete, insulated concrete form (ICF), masonry cavity, brick (other than brick veneer), earth (adobe, compressed earth block, rammed earth) and solid timber/logs, or any other walls meeting the following:

- Masonry or concrete walls having a mass greater than or equal to 30 pounds per square foot (146 kg/m²).
- Solid wood walls having a mass greater than 20 pounds per square foot (98 kg/m²).
- Any walls having a heat capacity greater than or equal to 6 Btu/ft² • °F [266 J/(m² • K)].

~~Mass walls where used as a component of the *building thermal envelope* shall be one of the following:~~

- ~~1. Above ground walls of concrete block, concrete, insulated concrete form, masonry cavity, brick but not brick veneer, adobe, compressed earth block, rammed earth, solid timber, mass timber or solid logs.~~
- ~~2. Any wall having a heat capacity greater than or equal to 6 Btu/ft² × °F (123 kJ/m² × K).~~

R402.2.7 Floors. Floor *cavity insulation* shall comply with one of the following:

1. Installation shall be installed to maintain permanent contact with the underside of the subfloor decking in accordance with manufacturer instructions to maintain required *R*-value or readily fill the available cavity space. The distance between tension support wires or other devices that hold the floor insulation in place against the subfloor shall be no more than 18 inches. In addition, supports shall be located no further than 6 inches from each end of the insulation.
2. Floor framing cavity insulation shall be permitted to be in contact with the top side of sheathing/gypsum separating the cavity and the unconditioned space below. Insulation shall extend from the bottom to the top of all perimeter floor framing members (the band boards) and the framing members shall be air sealed.
3. A combination of cavity and continuous insulation shall be installed so that the cavity insulation is in contact with the top side of the continuous insulation that is installed on the underside of the floor framing separating the cavity and the unconditioned space below. The combined *R*-value of the cavity and continuous insulation shall equal the required *R*-value for floors. Insulation shall extend from the bottom to the top of all perimeter floor framing members and the framing members shall be air sealed. •

R402.2.8.1 Basement wall insulation installation. Where *basement walls* are insulated, the insulation shall be installed from the top of the *basement wall* down to 10 feet (3048 mm) below grade or to the basement floor, whichever is less. Foam plastic insulation applied to exterior of basement walls shall be provided with termite inspection and treatment gaps in accordance with Appendix R2.

R402.2.9 Slab-on-grade floors. Slab-on-grade floors with a floor surface less than 12 inches (305 mm) below grade shall be insulated in accordance with Table R402.1.3.

Exception: ~~Slab edge insulation is not required in jurisdictions designated by the code official as having a very heavy termite infestation.~~ Deleted.

R402.2.9.1 Slab-on-grade floor insulation installation. Where installed, the insulation shall extend downward from the top of the slab on the outside or inside of the foundation wall. Insulation located below grade shall be extended the distance provided in Table R402.1.3 or the distance of the proposed design, as applicable, by any combination of vertical insulation, insulation extending under the slab or insulation extending out from the building. Insulation extending away from the building shall be protected by pavement or by not less than 10 inches (254 mm) of soil. The top edge of the insulation installed between the *exterior wall* and the edge of the interior slab shall be permitted to be cut at a 45-degree (0.79 rad) angle away from the *exterior wall*. Slab edge insulation shall have a 2-inch termite inspection gap consistent with Appendix R2 of this code.

R402.2.10 Crawl space walls. Crawl space walls shall be insulated in accordance with Table R402.1.3.

Exception: Crawl space walls associated with a crawl space that is vented to the outdoors and the floor overhead is insulated in accordance with Table R402.1.3 and Section R402.2.7.

R402.2.10.1 Crawl space wall insulation installations. Where crawl space wall insulation is installed, it shall be permanently fastened to the wall and shall extend downward from the floor to the finished grade elevation and then vertically or horizontally for not less than an additional 24 inches (610 mm). Exposed earth in unvented crawl space foundations shall be covered with a continuous Class I vapor retarder in accordance with the *International Building Code* or *International Residential Code*, as applicable. Joints of the vapor retarder shall overlap by 6 inches (153 mm) and be sealed or taped. The

edges of the vapor retarder shall extend not less than 6 inches (153 mm) up stem walls and shall be attached to the stem walls.

Wall insulation may be located in any combination of the outside and inside wall surfaces and within the structural cavities or materials of the wall system. Wall insulation requires that the exterior wall band joist area of the floor frame be insulated. Wall insulation shall begin 3 inches (76.2 mm) below the top of the masonry foundation wall and shall extend down to 3 inches (76.2 mm) above the top of the footing or concrete floor, 3 inches (76.2 mm) above the interior ground surface or 24 inches (609.6 mm) below the outside finished ground level, whichever is less. (See Appendix R1.2.2 details).

Termite inspection, clearance, and wicking gaps are allowed in wall insulation systems. Insulation may be omitted in the gap area without energy penalty. The allowable insulation gap widths are listed in Table 402.2.10. If gap width exceeds the allowances, one of the following energy compliance options shall be met:

1. Wall insulation is not allowed and the required insulation value shall be provided in the floor system.
2. Compliance shall be demonstrated with energy trade-off methods provided by the UA Alternative method or Section R401.2.2

TABLE R402.2.10
WALL INSULATION ALLOWANCES FOR TERMITE
TREATMENT AND INSULATION GAPS

GAP WIDTH (inches)		INSULATION LOCATION	GAP DESCRIPTION
Minimum	Maximum		
<u>2</u>	<u>3</u>	<u>Outside</u>	<u>Above grade inspection between top of insulation and bottom of siding</u>
<u>4</u>	<u>6</u>	<u>Outside</u>	<u>Below grade treatment</u>
<u>3^a</u>	<u>4^a</u>	<u>Inside</u>	<u>Wall inspection between top of insulation and bottom of sill</u>
<u>3^a</u>	<u>4^a</u>	<u>Inside</u>	<u>Clearance/wicking space between bottom of insulation and top of ground surface, footing, or concrete floor</u>

a. No insulation shall be required on masonry walls of 9 inches in height or less.

R402.2.12 Sunroom and heated garage insulation. Sunrooms enclosing conditioned space and heated garages shall meet the insulation requirements of this code.

Exception: For sunrooms and heated garages provided thermal isolation, and enclosed conditioned space, the following exceptions to the insulation requirements of this code shall apply:

1. The minimum ceiling insulation R-values shall be R-19 in Climate Zones ~~0 through 3~~ and 4 and R-24 in Climate Zone 5. ~~Zones 5 through 8.~~
2. The minimum wall insulation R-value shall be R-13 in all climate zones. Walls separating a sunroom or heated garage with thermal isolation from conditioned space shall comply with the building thermal envelope requirements of this code.

R402.3.5 Sunroom and heated garage fenestration. Sunrooms and heated garages enclosing conditioned space shall comply with the fenestration requirements of this code.

Exception: In Climate Zones ~~2 3~~ through 5, 8, for sunrooms and heated garages with thermal isolation and enclosing conditioned space, the fenestration U-factor shall not exceed 0.45 and the skylight U-factor shall not exceed 0.70.

New fenestration separating a sunroom or heated garage with thermal isolation from conditioned space shall comply with the building thermal envelope requirements of this code.

R402.4 Air leakage. The building thermal envelope shall be constructed to limit air leakage in accordance with the requirements of Sections R402.4.1 through R402.4.5.

R402.4.1 Building thermal envelope air leakage. The building thermal envelope shall comply with Sections R402.4.1.1 through R402.4.1.3. The sealing methods between dissimilar materials shall allow for differential expansion and contraction.

R402.4.1.2 Testing. The *building or dwelling unit* shall be tested for air leakage. The maximum air leakage rate for any *building or dwelling unit* under any compliance path shall not exceed ~~5.0~~ 4.0 air changes per hour or ~~0.28~~ 0.23 cubic feet per minute (CFM) per square foot [0.0079 m³/(s × m²)] of dwelling unit enclosure area. Testing shall be conducted in accordance with ANSI/RESNET/ICC 380, ASTM E779, ~~ASTM E3158~~ or ASTM E1827 and reported at a pressure of 0.2 inch w.g. (50 Pascals). Alternately, if using a higher test pressure of 0.30 in. w.g.(75 Pa), a maximum air leakage rate of 0.30 cubic feet per minute per square foot of dwelling unit enclosure area shall be met. Where required by the *code official*, testing shall be conducted by an *approved* third party. A written report of the results of the test shall be signed by the party conducting the test and provided to the *code official*. Testing shall be performed at any time after creation of all penetrations of the *building thermal envelope* have been sealed.

Exception: For heated, attached private garages and heated, detached private garages accessory to one- and two-family dwellings and townhouses not more than three stories above *grade plane* in height, building envelope tightness and insulation installation shall be considered acceptable where the items in Table R402.4.1.1, applicable to the method of construction, are field verified. Where required by the code official, an *approved* third party independent from the installer shall inspect both air barrier and insulation installation criteria. Heated, attached private garage space and heated, detached private garage space shall be thermally isolated from all other habitable, *conditioned spaces* in accordance with Sections R402.2.12 and R402.3.5, as applicable.

During testing:

1. Exterior windows and doors, fireplace and stove doors shall be closed, but not sealed, beyond the intended weath-erstripping or other infiltration control measures.
2. Dampers including exhaust, intake, makeup air, backdraft and flue dampers shall be closed, but not sealed beyond intended infiltration control measures.
3. Interior doors, where installed at the time of the test, shall be open.
4. Exterior or interior terminations for continuous ventilation systems shall be sealed.
5. Heating and cooling systems, where installed at the time of the test, shall be turned off.
6. Supply and return registers, where installed at the time of the test, shall be fully open.

Exception: ~~When testing individual *dwelling units*, an air leakage rate not exceeding 0.30 cubic feet per minute per square foot [0.008 m³/(s × m²)] of the dwelling unit enclosure area, tested in accordance with ANSI/RESNET/ICC 380, ASTM E779 or ASTM E1827 and reported at a pressure of 0.2 inch w.g. (50 Pa) shall be an accepted alternative permitted in all climate zones for:~~

- ~~1. Attached single and multiple family building *dwelling units*.~~
- ~~2. Buildings or *dwelling units* that are 1,500 square feet (139.4 m²) or smaller.~~

Exceptions:

1. When testing individual dwelling units, an air leakage rate not exceeding 0.30 cubic feet per minute per square foot [0.008 m³/(s × m²)] of the dwelling unit enclosure area, tested in accordance with ANSI/RESNET/ICC 380, ASTM E779 or ASTM E1827 and reported at a pressure of 0.2 inch w.g. (50 Pa), shall be an accepted alternative permitted in all climate zones for:
 - a. Attached single and multiple family building dwelling units.
 - b. Buildings or dwelling units that are 1,500 square feet (139.4 m²) or smaller.
2. For heated, attached private garages and heated, detached private garages accessory to one and two-family dwellings and townhouses not more than three stories above grade plane in height, building envelope tightness and insulation installation shall be considered acceptable where the items in Table R402.4.1.1, applicable to the method of construction, are field verified. Where required by the code official, an approved third party independent from the installer shall inspect both air barrier and insulation installation criteria. Heated, attached private garage space

and heated, detached private garage space shall be thermally isolated from all other habitable, conditioned spaces in accordance with Sections R402.2.12 and R402.3.5, as applicable.

Mechanical ventilation shall be provided in accordance with Section M1505 of the *International Residential Code* or Section 403.3.2 of the *International Mechanical Code*, as applicable, or with other *approved* means of ventilation.

R402.4.1.3 Leakage rate. When complying with Section R401.2.1, the building or dwelling unit shall have an air leakage rate not exceeding ~~5.0 air changes per hour in Climate Zones 0, 1 and 2, and~~ 3.0 air changes per hour in Climate Zones 3 through ~~8, 5,~~ when tested in accordance with Section R402.4.1.2.

~~**R402.4.4 Rooms containing fuel-burning appliances.** In Climate Zones 3 through 8, 5, where open combustion air ducts provide combustion air to open combustion fuel-burning appliances, the appliances and combustion air opening shall be located outside the *building thermal envelope* or enclosed in a room that is isolated from inside the thermal envelope. Such rooms shall be sealed and insulated in accordance with the envelope requirements of Table R402.1.3, where the walls, floors and ceilings shall meet a minimum of the *basement wall R-value* requirement. The door into the room shall be fully gasketed and any water lines and ducts in the room insulated in accordance with Section R403. The combustion air duct shall be insulated where it passes through *conditioned space* to an *R-value* of not less than R-8.~~

Exceptions:

- ~~1. Direct vent appliances with both intake and exhaust pipes installed continuous to the outside.~~
- ~~2. Fireplaces and stoves complying with Section R402.4.2 and Section R1006 of the *International Residential Code*.~~

~~**R402.4.5 R402.4.4 Recessed lighting.** Recessed luminaires installed in the *building thermal envelope* shall be sealed to limit air leakage between conditioned and *unconditioned spaces*. Recessed luminaires shall be IC-rated and labeled as having an air leakage rate of not greater than 2.0 cfm (0.944 L/s) when tested in accordance with ASTM E283 at a pressure differential of 1.57 psf (75 Pa). Recessed luminaires shall be sealed with a gasket or caulked between the housing and the interior wall or ceiling covering.~~

~~**R402.4.6 R402.4.5 Electrical and communication outlet boxes (air-sealed boxes).** Electrical and communication outlet boxes installed in the building thermal envelope shall be sealed to limit air leakage between conditioned and unconditioned spaces. Electrical and communication outlet boxes shall be tested in accordance with NEMA OS 4, *Requirements for Air-Sealed Boxes for Electrical and Communication Applications*, and shall have an air leakage rate of not greater than 2.0 cubic feet per minute (0.944 L/s) at a pressure differential of 1.57 psf (75 Pa). Electrical and communication outlet boxes shall be marked “NEMA OS 4” or “OS 4” in accordance with NEMA OS 4. Electrical and communication outlet boxes shall be installed per the manufacturer’s instructions and with any supplied components required to achieve compliance with NEMA OS 4.~~

~~**R402.5 Maximum fenestration U-factor and SHGC.** The area-weighted average maximum fenestration *U-factor* permitted using tradeoffs from Section R402.1.5 or R405 shall be 0.48 in Climate Zones 4 and 5 and 0.40 in Climate Zones 6 through 8 for vertical fenestration, and 0.75 in Climate Zones 4 through 8 5 for skylights. The area-weighted average maximum fenestration SHGC permitted using tradeoffs from Section R405 in *Climate Zones 0 through 3* shall be 0.40.~~

Exception: The maximum *U-factor* and solar heat gain coefficient (SHGC) for fenestration shall not be required in storm shelters complying with ICC 500.

SECTION R403 SYSTEMS

R403.3.3 Ducts buried within ceiling insulation. Where supply and return air ducts are partially or completely buried in ceiling insulation, such ducts shall comply with all of the following:

1. The supply and return ducts shall have an insulation *R-value* not less than R-8.

2. ~~In Zones 4 and 5, at~~ At all points along each duct, the sum of the ceiling insulation *R*-value against and above the top of the duct, and against and below the bottom of the duct, shall be not less than R-19, excluding the *R*-value of the duct insulation.
3. In Climate ~~Zones 0A, 1A, 2A and 3A~~ Zone 3, the supply ducts shall be completely buried within ceiling insulation, insulated to an *R*-value of not less than R-13 and in compliance with the vapor retarder requirements of Section 604.11 of the *International Mechanical Code* or Section M1601.4.6 of the *International Residential Code*, as applicable.

Exception: Sections of the supply duct that are less than 3 feet (914 mm) from the supply outlet shall not be required to comply with these requirements.

R403.3.6 Duct leakage. The total leakage of the ducts, where measured in accordance with Section R403.3.5, shall be as follows:

Duct testing shall be performed and reported by a certified BPI Envelope Professional, a certified HERS rater, or other certified third-party professional trained in duct leakage testing by the test equipment manufacturer.

1. Rough-in test: The total leakage shall be less than or equal to 4.0 cubic feet per minute (113.3 L/min) per 100 square feet (9.29 m²) of *conditioned floor area* where the air handler is installed at the time of the test. Where the air handler is not installed at the time of the test, the total leakage shall be less than or equal to 3.0 cubic feet per minute (85 L/min) per 100 square feet (9.29 m²) of *conditioned floor area*.
2. Postconstruction test: Total leakage shall be less than or equal to 4.0 cubic feet per minute (113.3 L/min) per 100 square feet (9.29 m²) of *conditioned floor area*.
3. Test for ducts within thermal envelope: Where all ducts and air handlers are located entirely within the *building thermal envelope*, total leakage shall be less than or equal to 8.0 cubic feet per minute (226.6 L/min) per 100 square feet (9.29 m²) of *conditioned floor area*.

R403.6 Mechanical ventilation. ~~As applicable, Buildings~~ buildings and dwelling units shall be provided with mechanical ventilation that complies with the requirements of the *International Residential Code* or *International Mechanical Code*, ~~as applicable~~, or with other approved means of ventilation. Outdoor air intakes and exhausts shall have automatic or gravity dampers that close when the ventilation system is not operating.

R403.6.1 Heat or energy recovery ventilation. Deleted. ~~Dwelling units shall be provided with a heat recovery or energy recovery ventilation system in Climate Zones 7 and 8. The system shall be balanced with a minimum sensible heat recovery efficiency of 65 percent at 32°F (0°C) at a flow greater than or equal to the design airflow.~~

SECTION R404 ELECTRICAL POWER AND LIGHTING SYSTEMS

R404.1 Lighting equipment. All permanently installed lighting fixtures, excluding kitchen appliance lighting fixtures, shall contain only high-efficacy lighting sources. ~~high efficacy lighting sources.~~

SECTION R405 TOTAL BUILDING PERFORMANCE

SECTION R406 ENERGY RATING INDEX COMPLIANCE ALTERNATIVE

TABLE R406.5
MAXIMUM ENERGY RATING INDEX

CLIMATE ZONE	ENERGY RATING INDEX
0-1	52

2	52
3	51
4	54
5	55
6	54
7	53
8	53

** SECTION R407
TROPICAL CLIMATE REGION COMPLIANCE PATH

R407.1 Scope. Deleted. This section establishes alternative criteria for residential buildings in the tropical region at elevations less than 2,400 feet (731.5 m) above sea level.

R407.2 Tropical climate region. Compliance with this section requires the following:

- ~~1. Not more than one-half of the *occupied* space is air conditioned.~~
- ~~2. The *occupied* space is not heated.~~
- ~~3. Solar, wind or other renewable energy source supplies not less than 80 percent of the energy for service water heating.~~
- ~~4. Glazing in *conditioned spaces* has a *solar heat gain coefficient* (SHGC) of less than or equal to 0.40, or has an overhang with a projection factor equal to or greater than 0.30.~~
- ~~5. Permanently installed lighting is in accordance with Section R404.~~
- ~~6. The exterior roof surface complies with one of the options in Table C402.3 of the *International Energy Conservation Code - Commercial Provisions* or the roof or ceiling has insulation with an *R value* of R-15 or greater. Where attics are present, attics above the insulation are vented and attics below the insulation are unvented.~~
- ~~7. Roof surfaces have a slope of not less than $\frac{1}{4}$ unit vertical in 12 units horizontal (21 percent slope). The finished roof does not have water accumulation areas.~~
- ~~8. Operable fenestration provides a ventilation area of not less than 14 percent of the floor area in each room. Alternatively, equivalent ventilation is provided by a ventilation fan.~~
- ~~9. Bedrooms with *exterior walls* facing two different directions have operable fenestration on exterior walls facing two directions.~~
- ~~10. Interior doors to bedrooms are capable of being secured in the open position.~~
- ~~11. A ceiling fan or ceiling fan rough in is provided for bedrooms and the largest space that is not used as a bedroom.~~

SECTION R408
ADDITIONAL EFFICIENCY PACKAGE OPTIONS

TABLE R405.4.2(1)
SPECIFICATIONS FOR THE STANDARD REFERENCE AND PROPOSED DESIGNS

BUILDING COMPONENT	STANDARD REFERENCE DESIGN	PROPOSED DESIGN
--------------------	---------------------------	-----------------

Above-grade walls	Type: mass where the proposed wall is a mass wall; otherwise wood frame.	As proposed
	Gross area: same as proposed.	As proposed
	<i>U</i> -factor: as specified in Table R402.1.2.	As proposed
	Solar absorptance = 0.75.	As proposed
	Emittance = 0.90.	As proposed
Basement and crawl space walls	Type: same as proposed.	As proposed
	Gross area: same as proposed.	As proposed
	<i>U</i> -factor: as specified in Table R402.1.2, with the insulation layer on the interior side of the walls.	As proposed
Above-grade floors	Type: wood frame.	As proposed
	Gross area: same as proposed.	As proposed
	<i>U</i> -factor: as specified in Table R402.1.2.	As proposed
Ceilings	Type: wood frame.	As proposed
	Gross area: same as proposed.	As proposed
	<i>U</i> -factor: as specified in Table R402.1.2.	As proposed
Roofs	Type: composition shingle on wood sheathing.	As proposed
	Gross area: same as proposed.	As proposed
	Solar absorptance = 0.75.	As proposed
	Emittance = 0.90.	As proposed
Attics	Type: vented with an aperture of 1 ft ² per 300 ft ² of ceiling area.	As proposed
Foundations	Type: same as proposed.	As proposed
	Foundation wall area above and below grade and soil characteristics: same as proposed.	As proposed
Opaque doors	Area: 40 ft ² .	As proposed
	Orientation: North.	As proposed
	<i>U</i> -factor: same as fenestration as specified in Table R402.1.2.	As proposed
Vertical fenestration other than opaque doors	Total area ^h — (a) The proposed glazing area, where the proposed glazing area is less than 45 <u>12</u> percent of the conditioned floor building thermal envelope above-grade wall area. (b) 45 <u>12</u> percent of the conditioned floor area, where the proposed glazing area is 45 <u>12</u> percent or more of the conditioned floor building thermal envelope above-grade wall area.	As proposed
	Orientation: equally distributed to four cardinal compass orientations (N, E, S & W).	As proposed
	<i>U</i> -factor: as specified in Table R402.1.2.	As proposed

	SHGC: as specified in Table R402.1.2 except for climate zones without an SHGC requirement, the SHGC shall be equal to 0.40.	As proposed
	Interior shade fraction: $0.92 - (0.21 \times \text{SHGC for the standard reference design})$.	Interior shade fraction: $0.92 - (0.21 \times \text{SHGC as proposed})$
	External shading: none	As proposed

(continued)

(continued)

TABLE R405.4.2(1)—continued
SPECIFICATIONS FOR THE STANDARD REFERENCE AND PROPOSED DESIGNS

BUILDING COMPONENT	STANDARD REFERENCE DESIGN	PROPOSED DESIGN
Skylights	None	As proposed
Thermally isolated sun-rooms	None	As proposed
Air exchange rate	The air leakage rate at a pressure of 0.2 inch w.g. (50 Pa) shall be Climate Zones 0 through 2: 5.0 air changes per hour. Climate Zones 3 through 5: 3.0 air changes per hour.	The measured air exchange rate. ^a
	The mechanical ventilation rate shall be in addition to the air leakage rate and shall be the same as in the proposed design, but not greater than $0.01 \times CFA + 7.5 \times (N_{br} + 1)$ where: CFA = conditioned floor area, ft ² . N_{br} = number of bedrooms. The mechanical ventilation system type shall be the same as in the proposed design. Energy recovery shall not be assumed for mechanical ventilation.	The mechanical ventilation rate ^b shall be in addition to the air leakage rate and shall be as proposed.
Mechanical ventilation	Where mechanical ventilation is not specified in the proposed design: None Where mechanical ventilation is specified in the proposed design, the annual vent fan energy use, in units of kWh/yr, shall equal $(1/e_f) \times [0.0876 \times CFA + 65.7 \times (N_{br} + 1)]$ where: e_f = the minimum exhaust fan efficacy, as specified in Table 403.6.2, corresponding to the system type at a flow rate of $0.01 \times CFA + 7.5 \times (N_{br} + 1)$ CFA = conditioned floor area, ft ² . N_{br} = number of bedrooms.	As proposed
Internal gains	IGain, in units of Btu/day per dwelling unit, shall equal $17,900 + 23.8 \times CFA + 4,104 \times N_{br}$ where: CFA = conditioned floor area, ft ² . N_{br} = number of bedrooms.	Same as standard reference design.

Internal mass	Internal mass for furniture and contents: 8 pounds per square foot of floor area.	Same as standard reference design, plus any additional mass specifically designed as a thermal storage element ^e but not integral to the building envelope or structure.
Structural mass	For masonry floor slabs: 80 percent of floor area covered by R-2 carpet and pad, and 20 percent of floor directly exposed to room air.	As proposed
	For masonry basement walls: as proposed, but with insulation as specified in Table R402.1.3, located on the interior side of the walls.	As proposed
	For other walls, ceilings, floors, and interior walls: wood frame construction.	As proposed
Heating systems ^{d, e}	For other than electric heating without a heat pump: as proposed. Where the proposed design utilizes electric heating without a heat pump, the standard reference design shall be an air source heat pump meeting the requirements of Section C403 of the IECC—Commercial Provisions. Capacity: sized in accordance with Section R403.7.	As proposed
Cooling systems ^{d, f}	As proposed. Capacity: sized in accordance with Section R403.7.	As proposed

(continued)

(continued)

TABLE R405.4.2(1)—continued
SPECIFICATIONS FOR THE STANDARD REFERENCE AND PROPOSED DESIGNS

BUILDING COMPONENT	STANDARD REFERENCE DESIGN	PROPOSED DESIGN		
Service water heating ^{d, g}	As proposed. Use, in units of gal/day = $30 + (10 \times N_{br})$ where: N_{br} = number of bedrooms.	As proposed Use, in units of gal/day = $25.5 + (8.5 \times N_{br}) \times (1 - HWDS)$ where: N_{br} = number of bedrooms. $HWDS$ = factor for the compactness of the hot water distribution system.		
		Compactness ratioⁱ factor		HWDS
		1 story	2 or more stories	
		> 60%	> 30%	0
		> 30% to ≤ 60%	> 15% to ≤ 30%	0.05
		> 15% to ≤ 30%	> 7.5% to ≤ 15%	0.10
		< 15%	< 7.5%	0.15

Thermal distribution systems	<p>Duct insulation: in accordance with Section R403.3.1.</p> <p>A thermal distribution system efficiency (DSE) of 0.88 shall be applied to both the heating and cooling system efficiencies for all systems other than tested duct systems.</p> <p>Duct location: same as proposed design.</p> <p>Exception: For nonducted heating and cooling systems that do not have a fan, the standard reference design thermal distribution system efficiency (DSE) shall be 1. For tested duct systems, the leakage rate shall be 4 cfm (113.3 L/min) per 100 ft² (9.29 m²) of <i>conditioned floor area</i> at a pressure of differential of 0.1 inch w.g. (25 Pa).</p>	<p>Duct insulation: as proposed.</p> <p>As tested or, where not tested, as specified in Table R405.4.2(2).</p>
Thermostat	<p>Type: Manual, cooling temperature setpoint = 75°F; Heating temperature setpoint = 72°F.</p>	<p>Same as standard reference design.</p>
Dehumidistat	<p>Where a mechanical ventilation system with latent heat recovery is not specified in the proposed design:</p> <p>None.</p> <p>Where the proposed design utilizes a mechanical ventilation system with latent heat recovery:</p> <p>Dehumidistat type: manual, setpoint = 60% relative humidity.</p> <p>Dehumidifier: whole-dwelling with integrated energy factor = 1.77 liters/kWh.</p>	<p>Same as standard reference design.</p>

For SI: 1 square foot = 0.93 m², 1 British thermal unit = 1055 J, 1 pound per square foot = 4.88 kg/m², 1 gallon (US) = 3.785 L, °C = (°F-32)/1.8, 1 degree = 0.79 rad.

g. For a proposed design with a nonstorage-type water heater, a 40-gallon storage-type water heater having the prevailing federal minimum energy factor for the same fuel as the predominant heating fuel type shall be assumed. For a proposed design without a proposed water heater, a 40-gallon storage-type water heater having the prevailing federal minimum efficiency for the same fuel as the predominant heating fuel type shall be assumed for both the proposed design and standard reference design.

h. Not Used

TABLE R405.4.2(1)—continued

SPECIFICATIONS FOR THE STANDARD REFERENCE AND PROPOSED DESIGNS

g. For a proposed design with a nonstorage-type water heater, a 40-gallon storage-type water heater having the prevailing federal minimum energy factor for the same fuel as the predominant heating fuel type shall be assumed. For a proposed design without a proposed water heater, a 40-gallon storage-type water heater having the prevailing federal minimum efficiency for the same fuel as the predominant heating fuel type shall be assumed for both the proposed design and standard reference design.

h. For residences with conditioned basements, R-2 and R-4 residences, and for townhouses, the following formula shall be used to determine glazing area:

$$AF = A_s \times FA \times F$$

where:

AF = Total glazing area.

A_s = Standard reference design total glazing area.

FA = (Above-grade thermal boundary gross wall area)/(above-grade boundary wall area + 0.5 × below-grade boundary wall area).

F = (above-grade thermal boundary wall area)/(above-grade thermal boundary wall area + common wall area) or 0.56, whichever is greater.

and where:

— Thermal boundary wall is any wall that separates conditioned space from unconditioned space or ambient conditions.

— Above-grade thermal boundary wall is any thermal boundary wall component not in contact with soil.

— Below-grade boundary wall is any thermal boundary wall in soil contact.

— Common wall area is the area of walls shared with an adjoining dwelling unit.

i. The factor for the compactness of the hot water distribution system is the ratio of the area of the rectangle that bounds the source of hot water and the fixtures that it serves (the “hot water rectangle”) divided by the floor area of the dwelling.

1. Sources of hot water include water heaters, or in multiple-family buildings with central water heating systems, circulation loops or electric heat traced pipes.

2. The hot water rectangle shall include the source of hot water and the points of termination of all hot water fixture supply piping.

3. The hot water rectangle shall be shown on the floor plans and the area shall be computed to the nearest square foot.

4. Where there is more than one water heater and each water heater serves different plumbing fixtures and appliances, it is permissible to establish a separate hot water rectangle for each hot water distribution system and add the area of these rectangles together to determine the compactness ratio.
5. The basement or attic shall be counted as a story when it contains the water heater.
6. Compliance shall be demonstrated by providing a drawing on the plans that shows the hot water distribution system rectangle(s), comparing the area of the rectangle(s) to the area of the dwelling and identifying the appropriate compactness ratio and *HWDS* factor.

CHAPTER 5 [RE] EXISTING BUILDINGS

User note:

— About this chapter: Many buildings are renovated or altered in numerous ways that could affect the energy use of the building as a whole. Chapter 5 requires the application of certain parts of Chapter 4 in order to maintain, if not improve, the conservation of energy by the renovated or altered building.

SECTION R503 ALTERATIONS

R503.1.1 Building envelope. Building envelope assemblies that are part of the *alteration* shall comply with Section R402.1.2 or R402.1.4, Sections R402.2.1 through R402.2.12, R402.3.1, R402.3.2, R402.4.3 and R402.4.5.

Exception: The following alterations shall not be required to comply with the requirements for new construction provided that the energy use of the building is not increased:

1. Storm windows installed over existing fenestration.
2. Existing ceiling, wall or floor cavities exposed during construction provided that these cavities are filled with insulation. Minimally this shall require; 2x4 cavity – R-13, 2x6 cavity – R-19, 2x8 cavity – R-30, 2x10 cavity – R-30, 2x12 cavity – R-38. See Section 504 Repairs for more specific language for repairs. Ventilated cladding air spaces shall not be required to be filled.
3. Construction where the existing roof, wall or floor cavity is not exposed.
4. Roof recover.
5. Roofs without insulation in the cavity and where the sheathing or insulation is exposed during reroofing shall be insulated either above or below the sheathing.
6. Surface-applied window film installed on existing single pane fenestration assemblies to reduce solar heat gain provided that the code does not require the glazing or fenestration assembly to be replaced.

CHAPTER 6 [RE] REFERENCED STANDARDS

User note:

- ~~**About this chapter:** This code contains numerous references to standards promulgated by other organizations that are used to provide requirements for materials and methods of construction. Chapter 6 contains a comprehensive list of all standards that are referenced in this code. These standards, in essence, are part of this code to the extent of the reference to the standard.~~
 - ~~This chapter lists the standards that are referenced in various sections of this document. The standards are listed herein by the promulgating agency of the standard, the standard identification, the effective date and title, and the section or sections of this document that reference the standard. The application of the referenced standards shall be as specified in Section R108.~~
-
-
-

Note to ICC Editor: Appendix R1 – R3 and the subcategories are unique to NC, therefore they are intended to be published as-is, the underlines are to illustrate changes from the 2018 NC-specific code, not the ICC model language._____

APPENDIX R1
RESIDENTIAL REQUIREMENTS

*This appendix is a North Carolina Appendix exclusive to the State of North Carolina,
and not part of the 2021 International Energy Conservation Code.
(The provisions contained in this appendix are adopted as part of this code)*

Appendix R1.1 Energy Efficiency Certificate (Section R401.3)

TABLE R401.3
ENERGY EFFICIENCY CERTIFICATE

Energy Efficiency Certificate – Code Edition Permitted under: _____		
Energy Code Compliance path used (Circle one): 1.Prescriptive 2.Total Building Performance 3.ERI		
Builder, Permit Holder or Registered Design Professional: Print Name: Signature:		
Property Address:		
Date:		
Insulation Rating – List the value covering largest area to all that apply		R-value
Ceiling/roof:		R-
Wall:		R-
Floor:		R-
Closed crawl space wall:		R-
Closed crawl space floor:		R-
Slab:		R-
Basement wall:		R-
Fenestration		
Fenestration (excluding skylights)		U- U _{w.a.} -
Fenestration (Skylights)		U- U _{w.a.} -
Solar Heat Gain Coefficient (SHGC)(All glazed fenestration)		SHGC - SHGC _{w.a.} -
Building Air Leakage		
Building air leakage test results (See N1102.4.1.2, R402.4.1.2) Target value: 4.0 ACH@50; or see N1102.4 (R402.4.1.2) for alternate test pressures and leakage allowance values.		
Name of Tester/Company:		
Date of test:		Phone:
Ducts:		
Insulation		R-
Total Duct leakage test result (N1103.3.6, R403.3.6) Target value: 4.0 CFM per 100 sq. ft. of conditioned floor area, at test pressure of 0.1 inch of w.g. (25 Pascals); or 8.0 CFM per 100 sq. ft. of conditioned floor area, at test pressure of 0.1 inch of w.g. (25 Pascals) if all ductwork is within building thermal envelope		
Name of Tester or Company:		
Date of Test:		Phone:
Heating/Cooling Equipment		
Type(s):		

Size(s) Btu/hr:	Fuel-fired Efficiency:	Heat pump and/or AC SEER, HSPF:
Water heating		
Type(s)		
Size(s) (Watts or Btu/hr):	Fuel fired efficiency:	Heat pump Water heater COP:
Where a gas-fired unvented room heater, electric furnace or baseboard electric heater is installed in the residence, the certificate shall indicate “ gas-fired unvented room heater, ” “ electric furnace ” or “ baseboard electric heater, ” as appropriate:		
Energy Rating Index:		
If, and only if the ERI pathway was used, write the ERI Score:		
Without On-Site generation:		With On-Site generation (if applicable):
Certificate to be displayed permanently- per N1101.14 (R401.3)		

**APPENDIX R1.2
INSULATION AND AIR SEALING DETAILS**

APPENDIX R1.2.1 (Section R402.2.1)

R402.2.1 Ceilings with attic spaces: Allowance for reduced insulation if full-height insulation is provided over the wall top plate at the eaves.

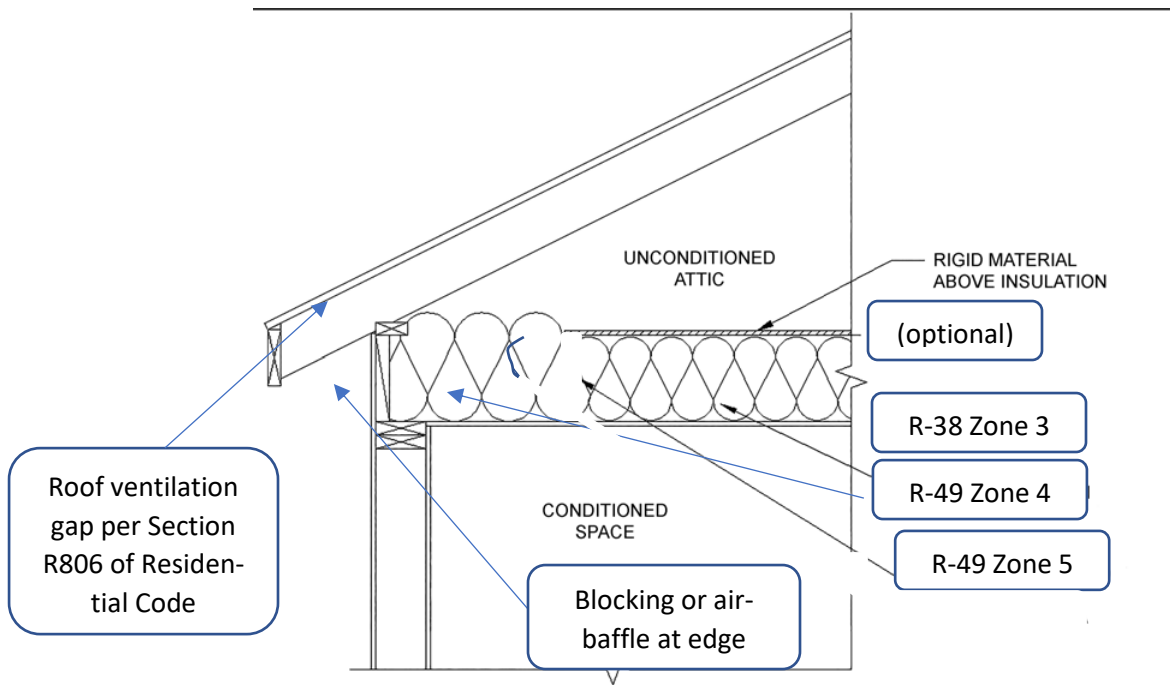

R402.2.1 Ceilings with attic spaces: Allowance for reduced insulation if full-height insulation is provided over the walls eaves – Optional method. Formerly “Fully enclosed enclosed attic floor assembly-2018 NC ECC”

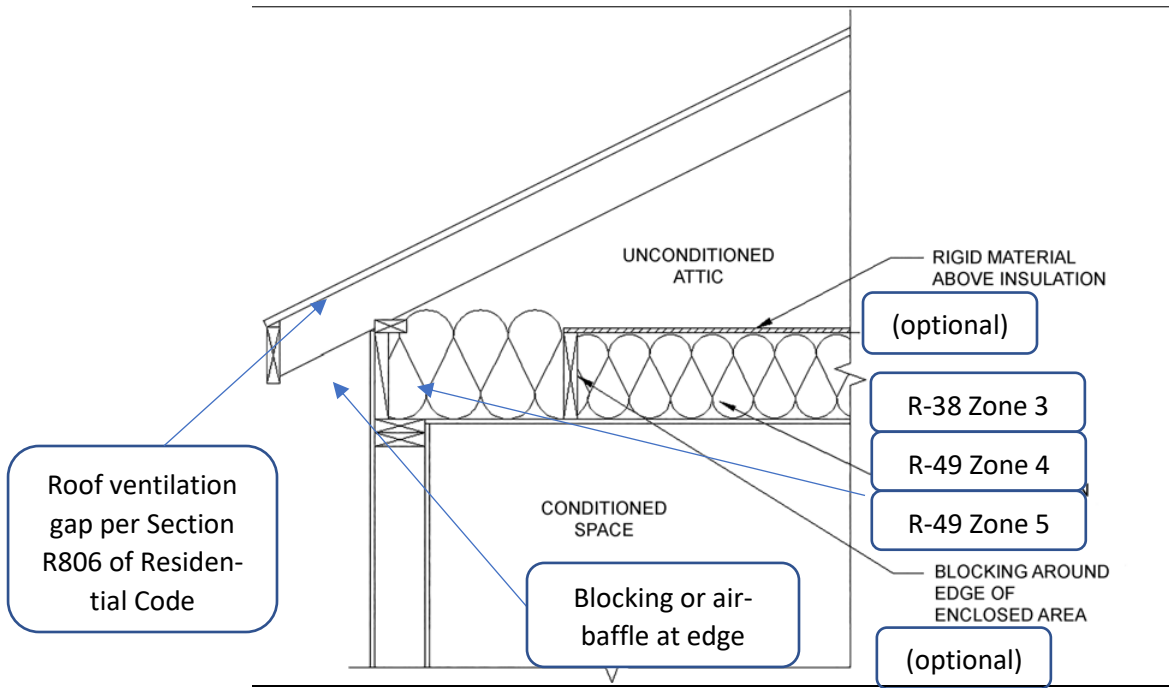

R402.2.1 Ceilings with attic spaces: Exception for fully enclosed attic floor systems.

APPENDIX R1.2.2 (Section R402.2.10)

R402.2.10 Closed crawl space walls. Insulation illustrations.

FOAM OR POROUS INSULATION HAS 3" TO 4" TOP INSPECTION GAP AND EXTENDS DOWN 3" TO 4" ABOVE TOP OF WALL FOOTING OR CONCRETE FLOOR

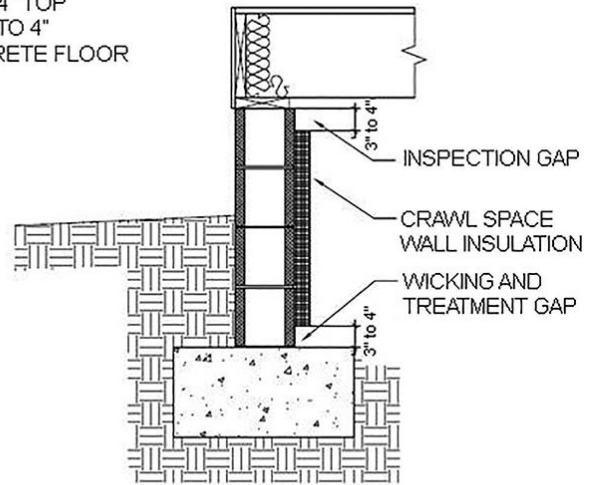

FOAM OR POROUS INSULATION HAS 3" TO 4" TOP INSPECTION GAP AND EXTENDS DOWN 24" BELOW GRADE

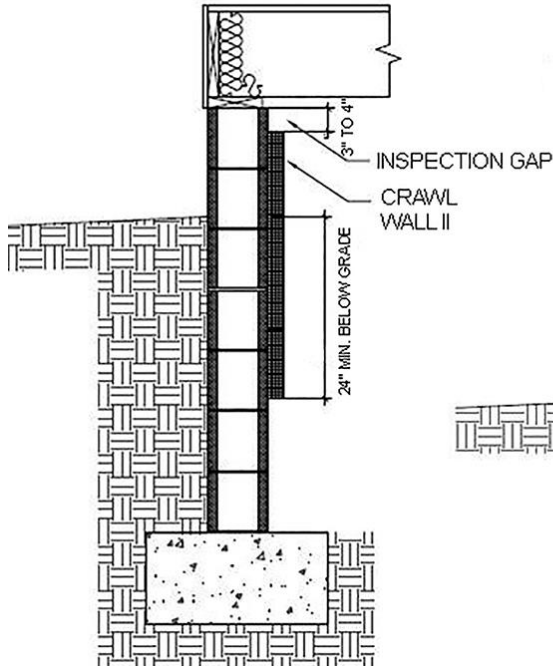

FOAM OR POROUS INSULATION HAS 3" TO 4" TOP INSPECTION GAP AND EXTENDS DOWN 3" TO 4" ABOVE INTERIOR GROUND SURFACE

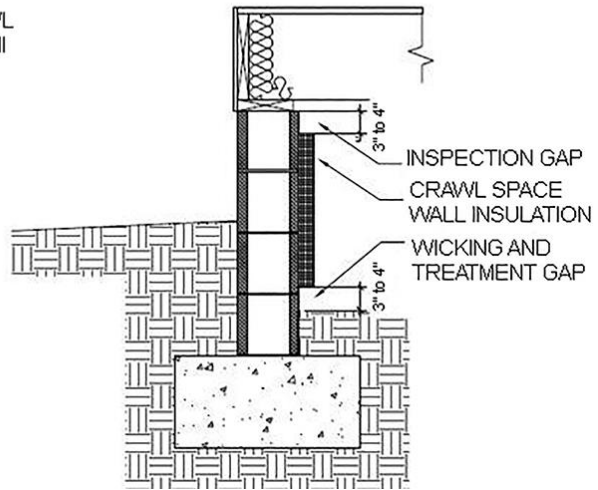

APPENDIX R1.2.3 (Section R402.4.1.1, Table R402.4.1.1)

Table R402.4.1.1 Air Barrier, Air Sealing and Insulation Installation. Shower/Tub on exterior wall

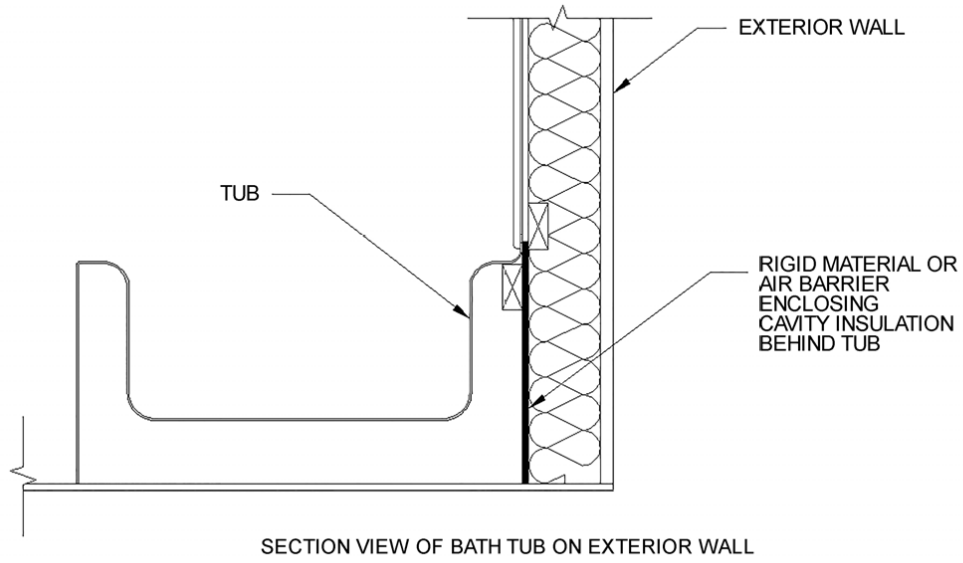
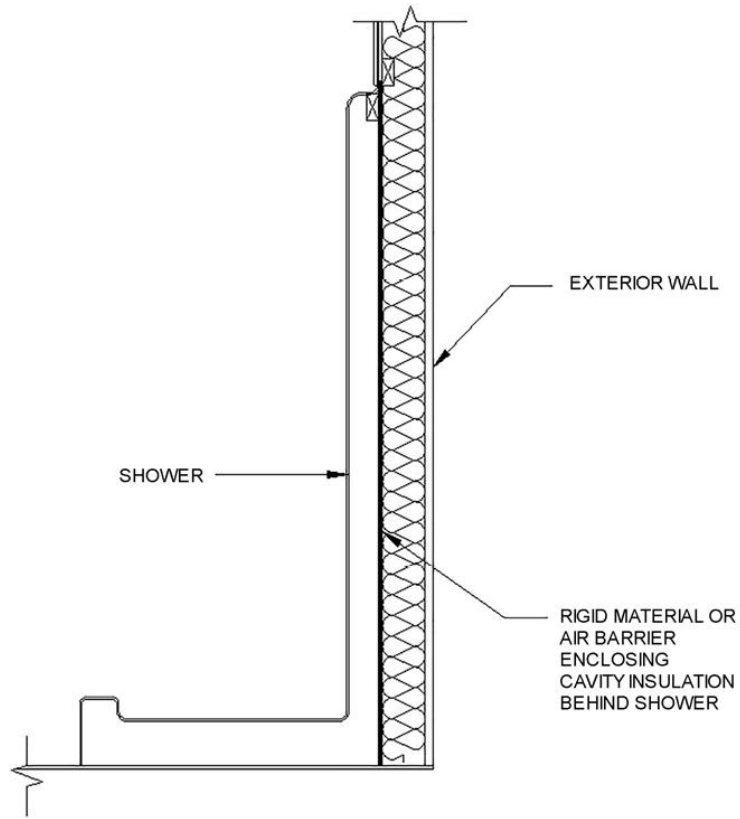
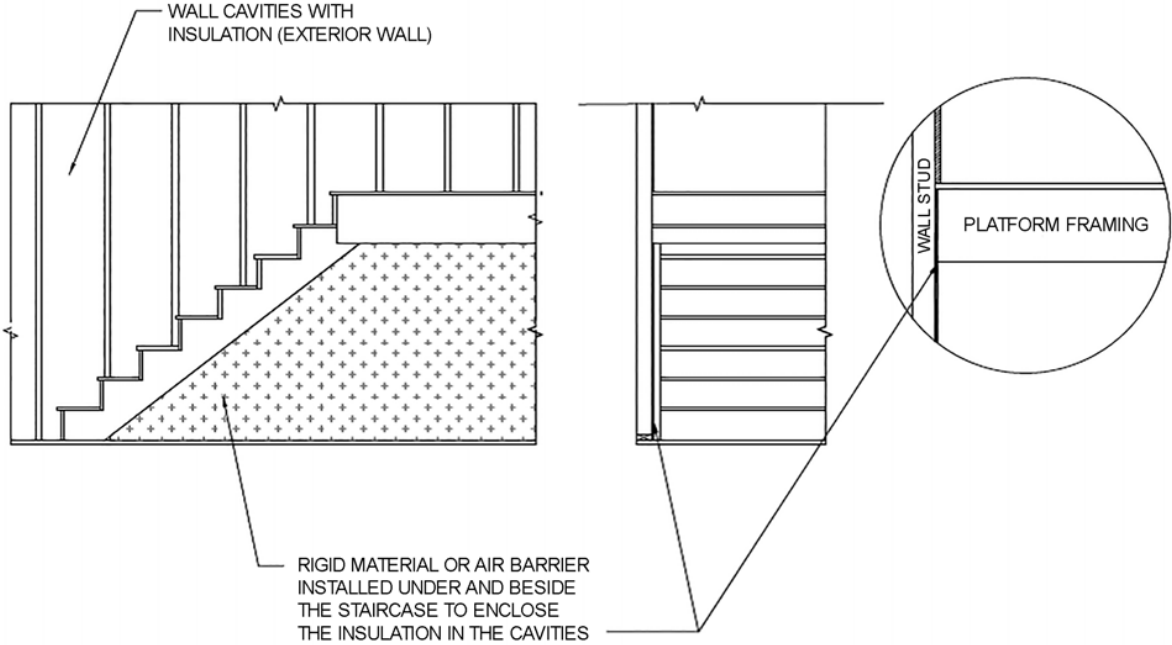

Table R402.4.1.1 Air Barrier, Air Sealing and Insulation Installation. Shower/tub on exterior wall



SECTION VIEW OF SHOWER ON EXTERIOR WALL

Table R402.4.1.1 Air Barrier, Air Sealing, and Insulation Installation – General Requirements



SECTION VIEW OF INTERIOR STAIRCASE ON EXTERIOR WALL (OPTION 1)

Table R402.4.1.1 Air Barrier, Air Sealing, and Insulation Installation – General Requirements

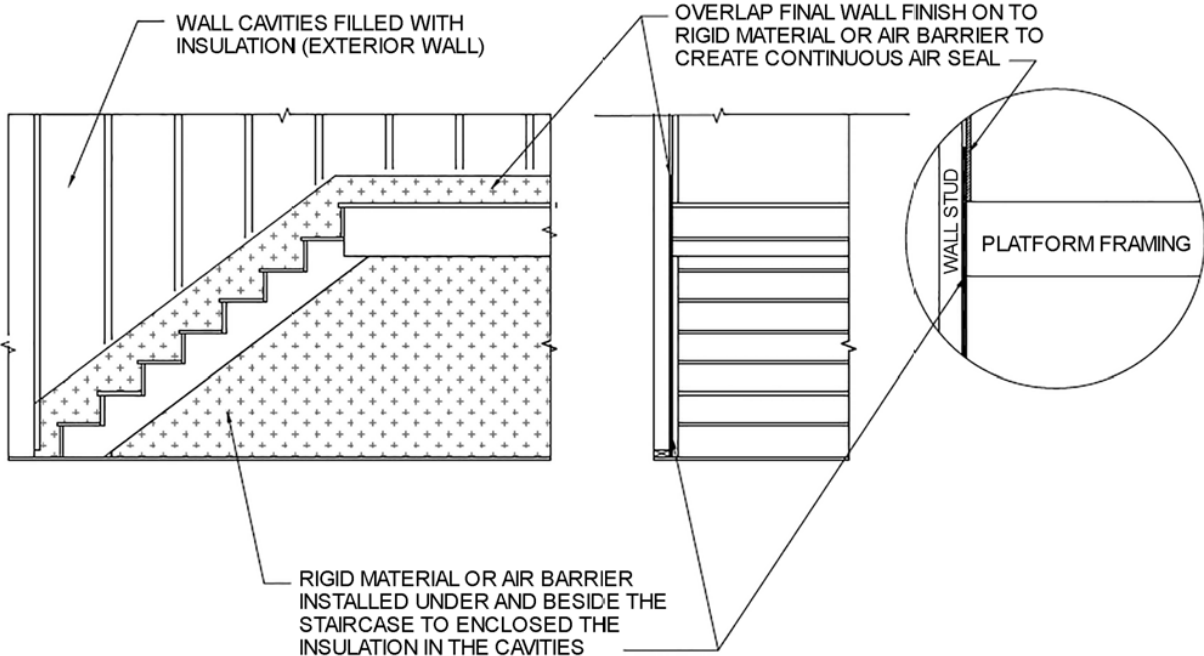

SECTION VIEW OF INTERIOR STAIRCASE ON EXTERIOR WALL (OPTION 2)

Table R402.4.1.1 Air Barrier, Air Sealing, and Insulation Installation – Shafts, penetrations, Flue Shaft.

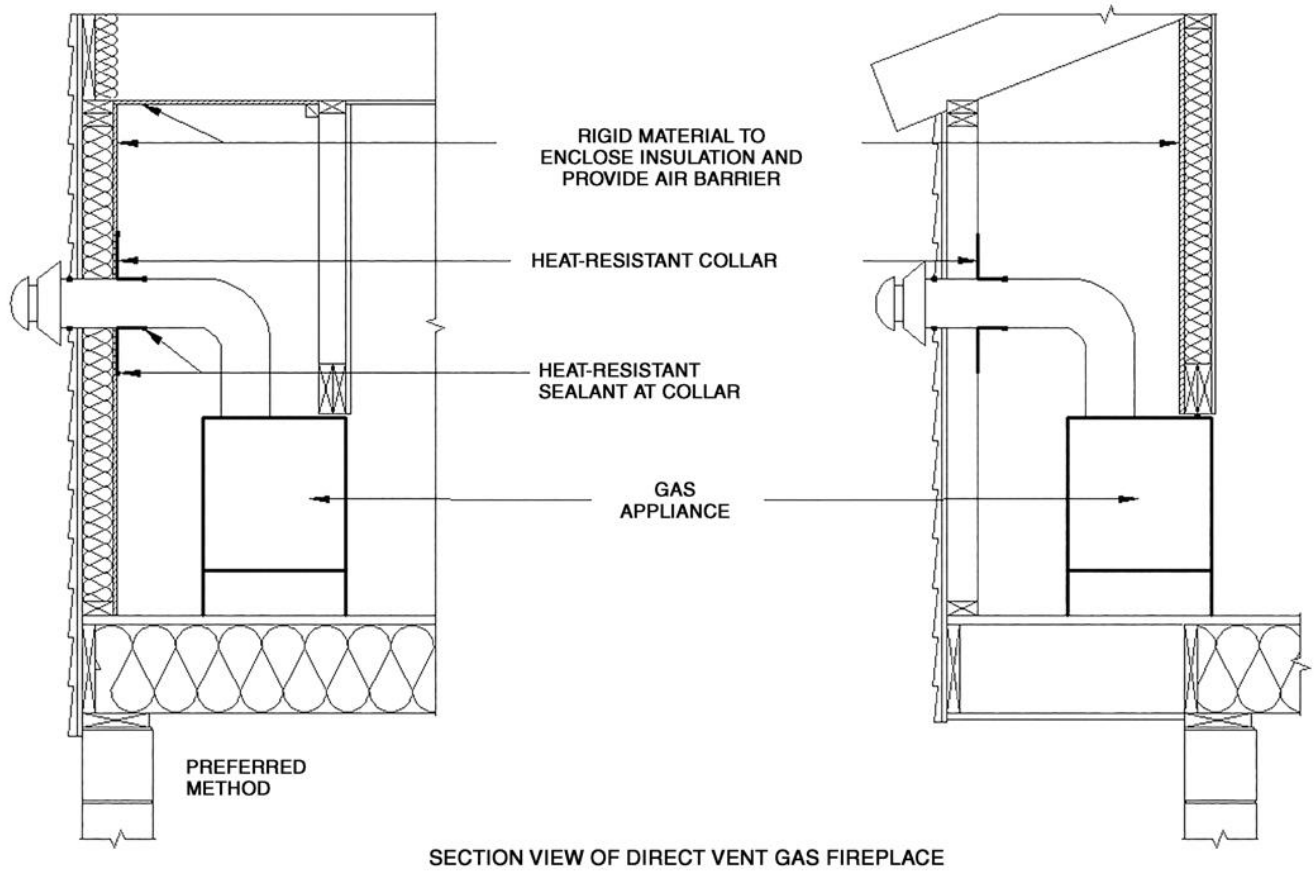
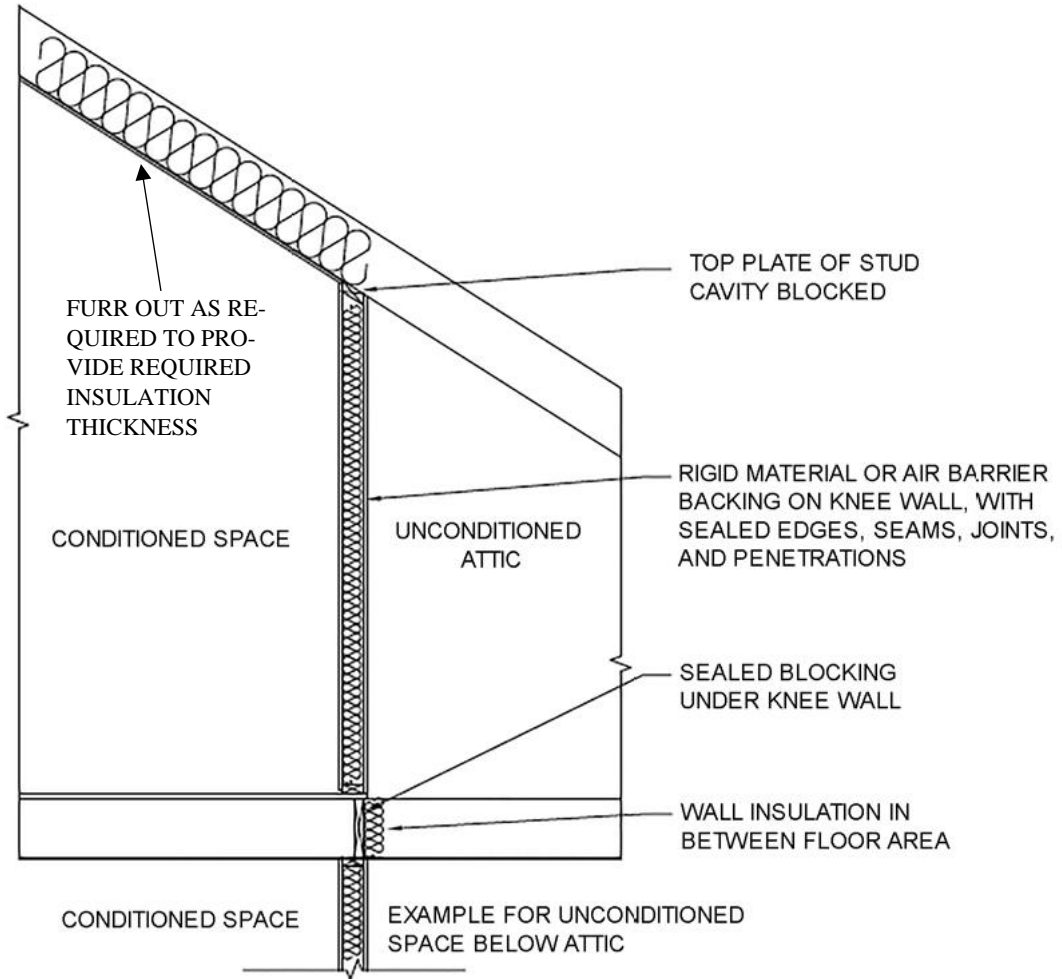
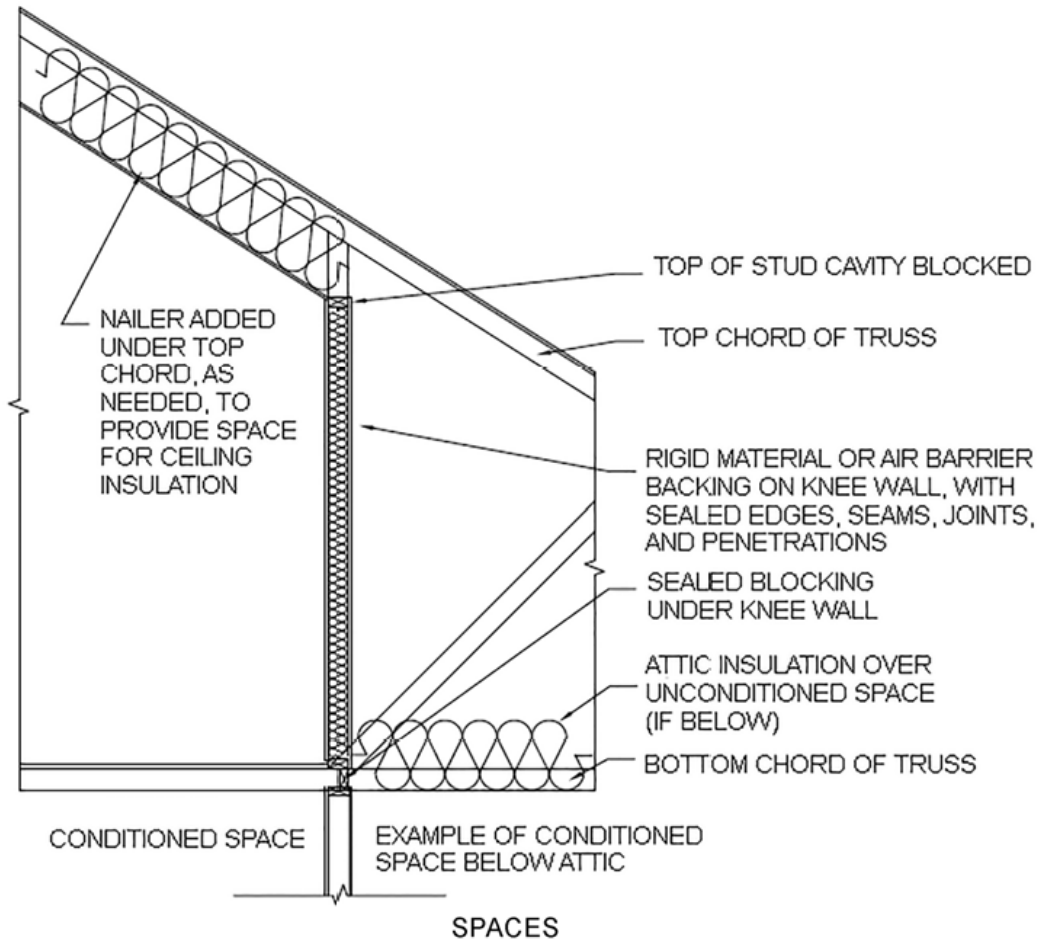

Table R402.4.1.1 Air Barrier, Air Sealing, and Insulation Installation – Walls, Knee walls, stick framed roof



SECTION VIEW OF WALL ADJOINING ATTIC SPACE WITH STICK FRAMED ROOF

Table R402.4.1.1 Air Barrier, Air Sealing, and Insulation Installation – Walls, Knee walls, trusses



SECTION VIEW OF WALL ADJOINING ATTIC SPACE WITH TRUSS ROOF

Table R402.4.1.1 Air Barrier, Air Sealing, and Insulation Installation – Cantilevered floor – dimensional lumber

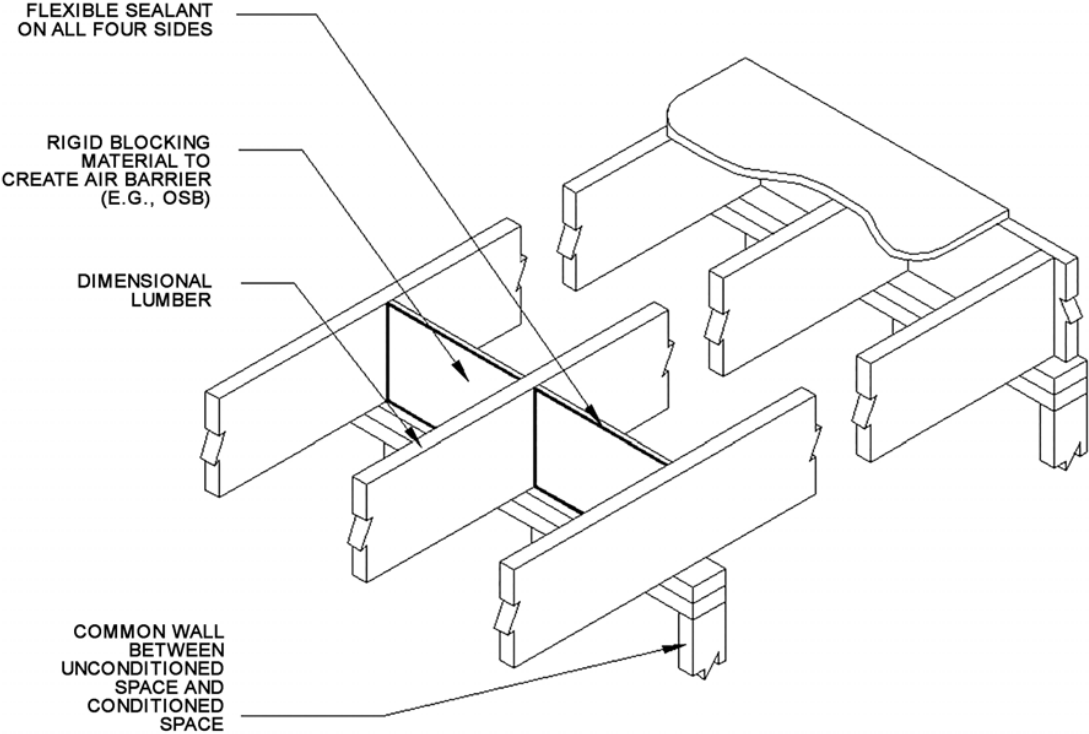

ISOMETRIC VIEW OF DIMENSIONAL LUMBER FLOOR/CEILING SYSTEM ABOVE COMMON WALL BETWEEN UNCONDITIONED AND CONDITIONED SPACE

Table R402.4.1.1 Air Barrier, Air Sealing, and Insulation Installation – Cantilevered floor – floor trusses

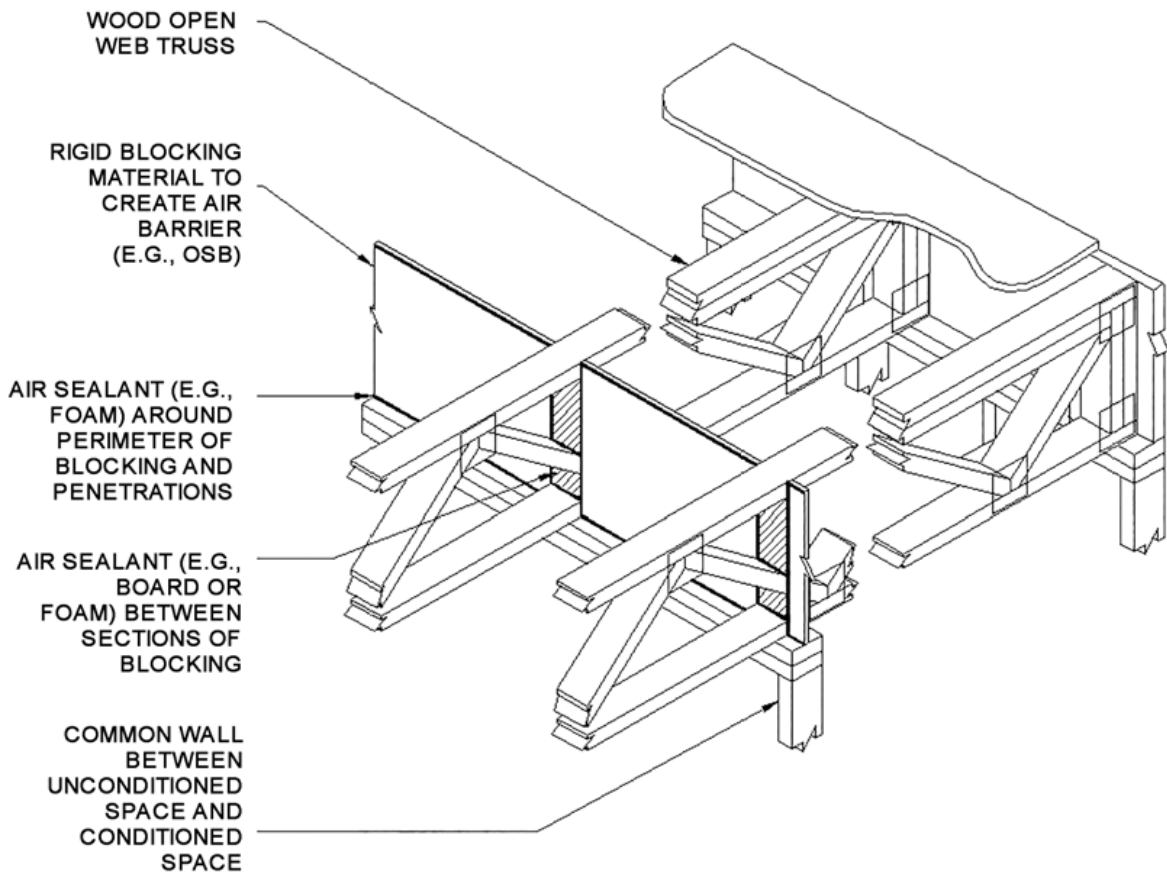

ISOMETRIC VIEW OF WOOD TRUSS FLOOR/CEILING SYSTEM ABOVE COMMON WALL BETWEEN UNCONDITIONED AND CONDITIONED SPACE

Table R402.4.1.1 Air Barrier, Air Sealing, and Insulation Installation – Cantilevered floor – I-joists

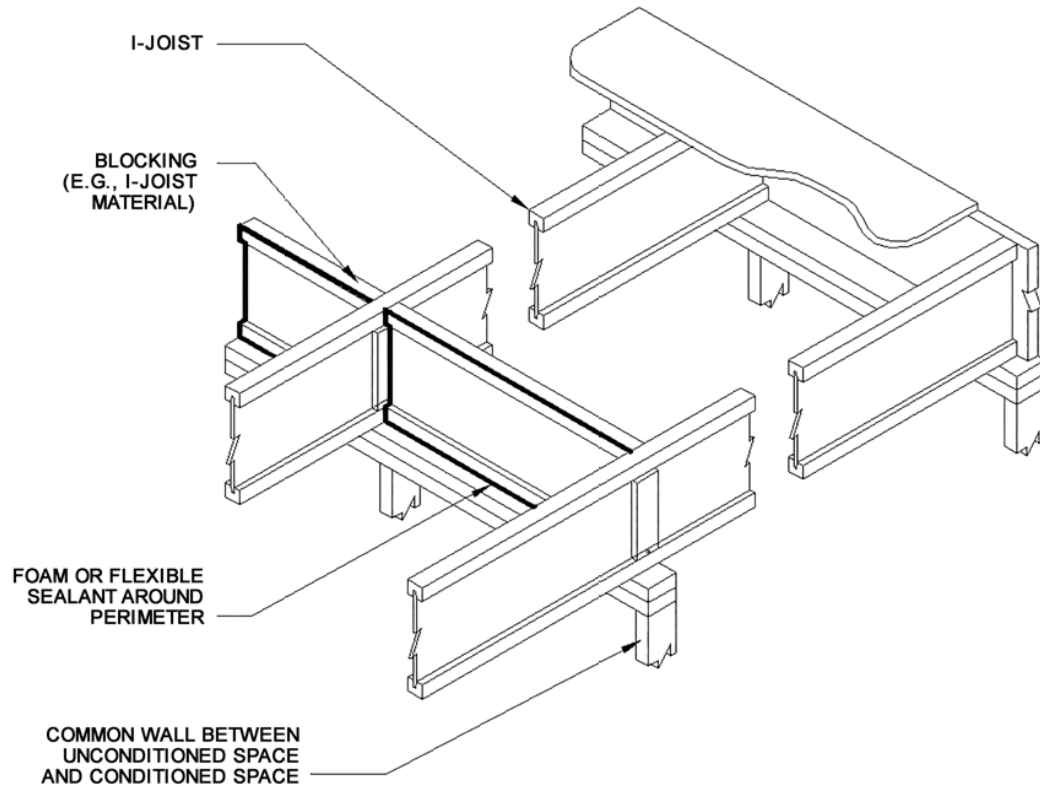

**ISOMETRIC VIEW OF I-JOIST FLOOR/CEILING SYSTEM ABOVE COMMON
WALL BETWEEN UNCONDITIONED AND CONDITIONED SPACE**

Table R402.4.1.1 Air Barrier, Air Sealing, and Insulation Installation – Shafts, penetrations

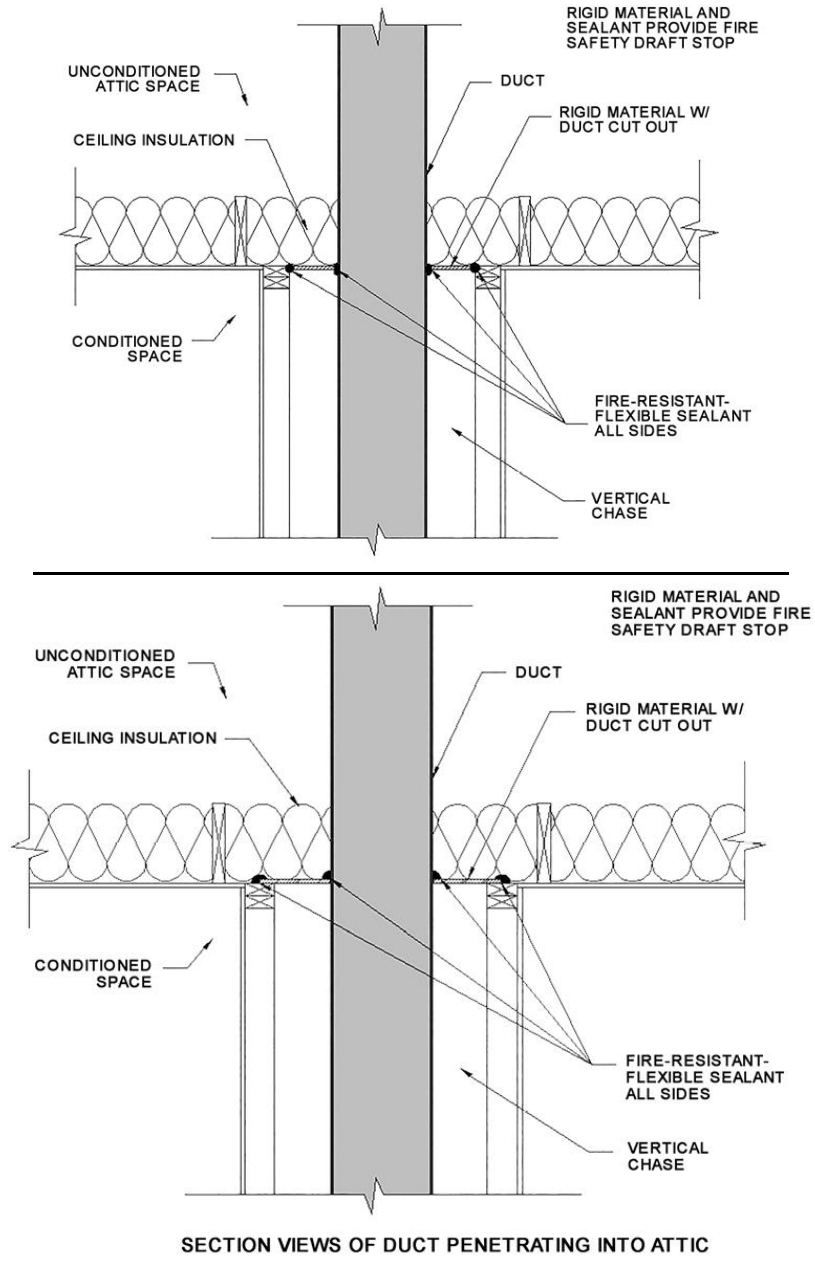
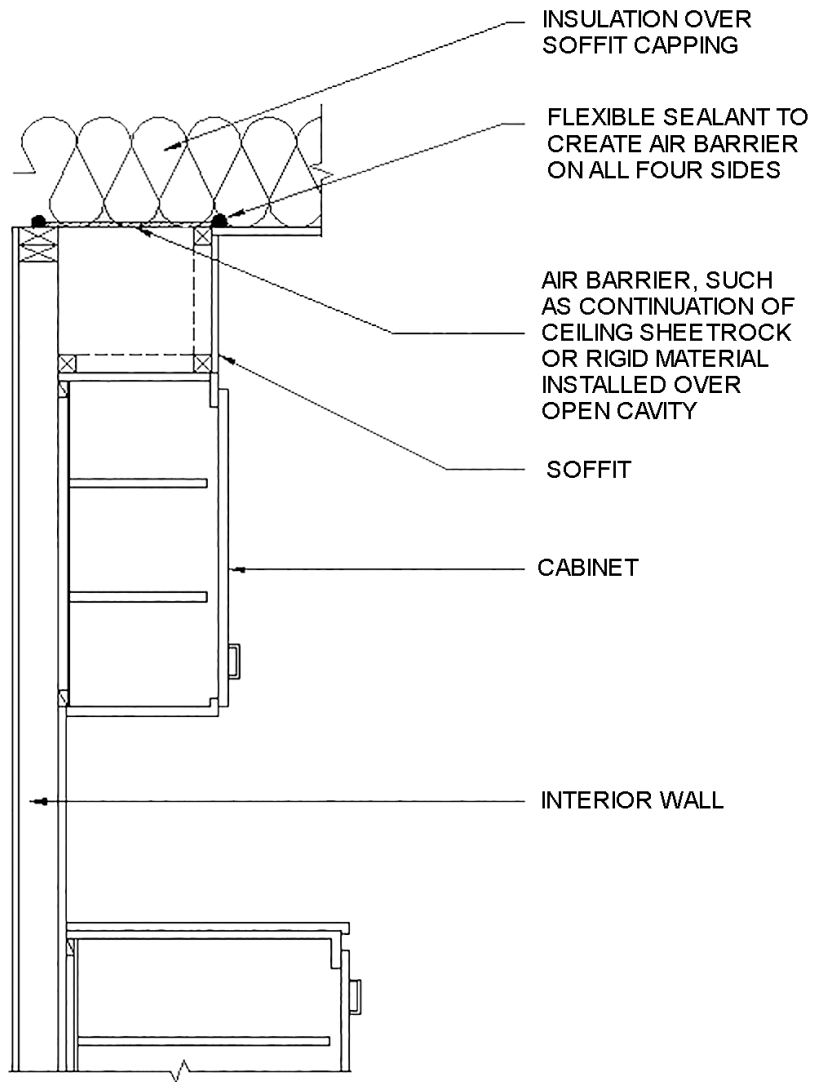
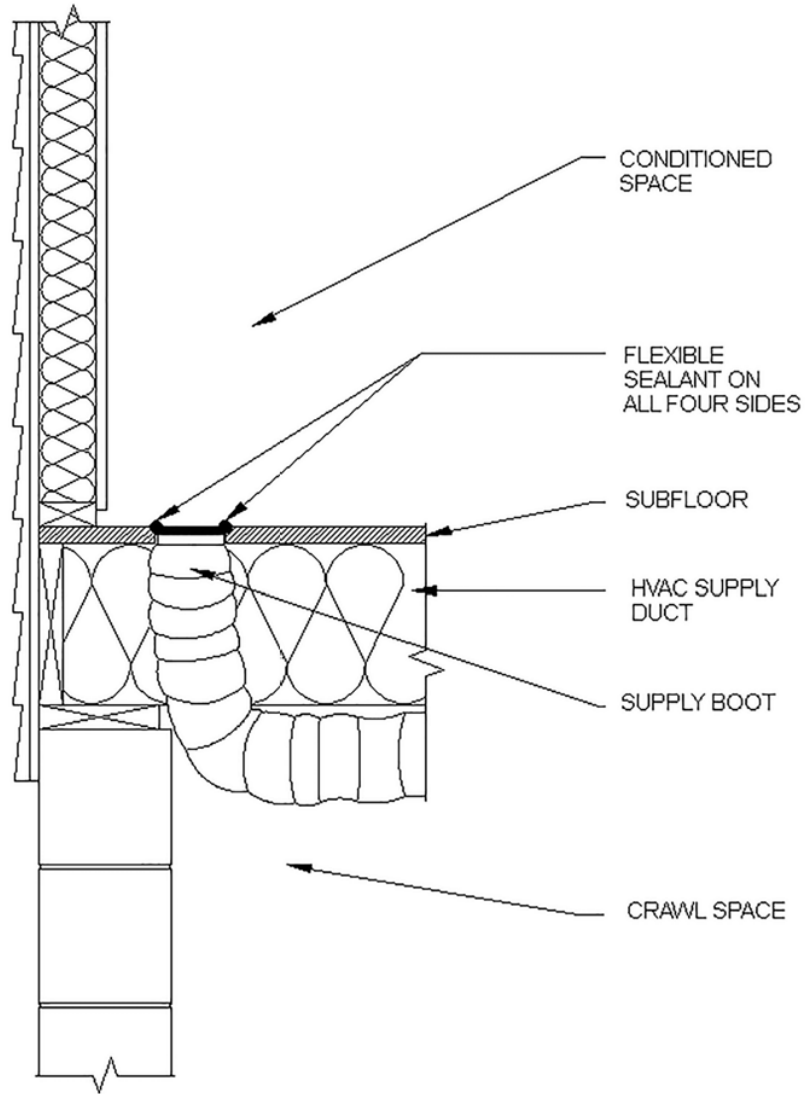

Table R402.4.1.1 Air Barrier, Air Sealing, and Insulation Installation – Ceiling/attic – dropped soffit



SECTION VIEW OF SOFFIT OVER CABINET

Table R402.4.1.1 Air Barrier, Air Sealing, and Insulation Installation – HVAC register boots - floor



SECTION VIEW OF FLOOR HVAC BOOT PENETRATION

Table R402.4.1.1 Air Barrier, Air Sealing, and Insulation Installation – HVAC register boots - ceiling

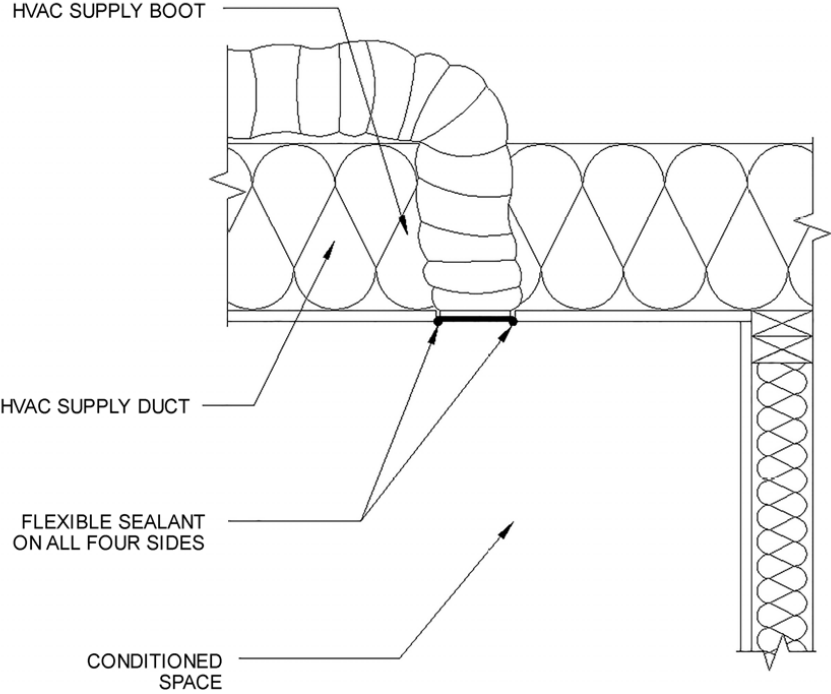

SECTION VIEW OF CEILING HVAC BOOT PENETRATION



Table R402.4.1.1 Air Barrier, Air Sealing, and Insulation Installation – General requirements – housewrap option

Follow manufacturer’s instructions for sealing air barrier-rated housewrap, including choice of materials, to provide an exterior air barrier at the following locations:

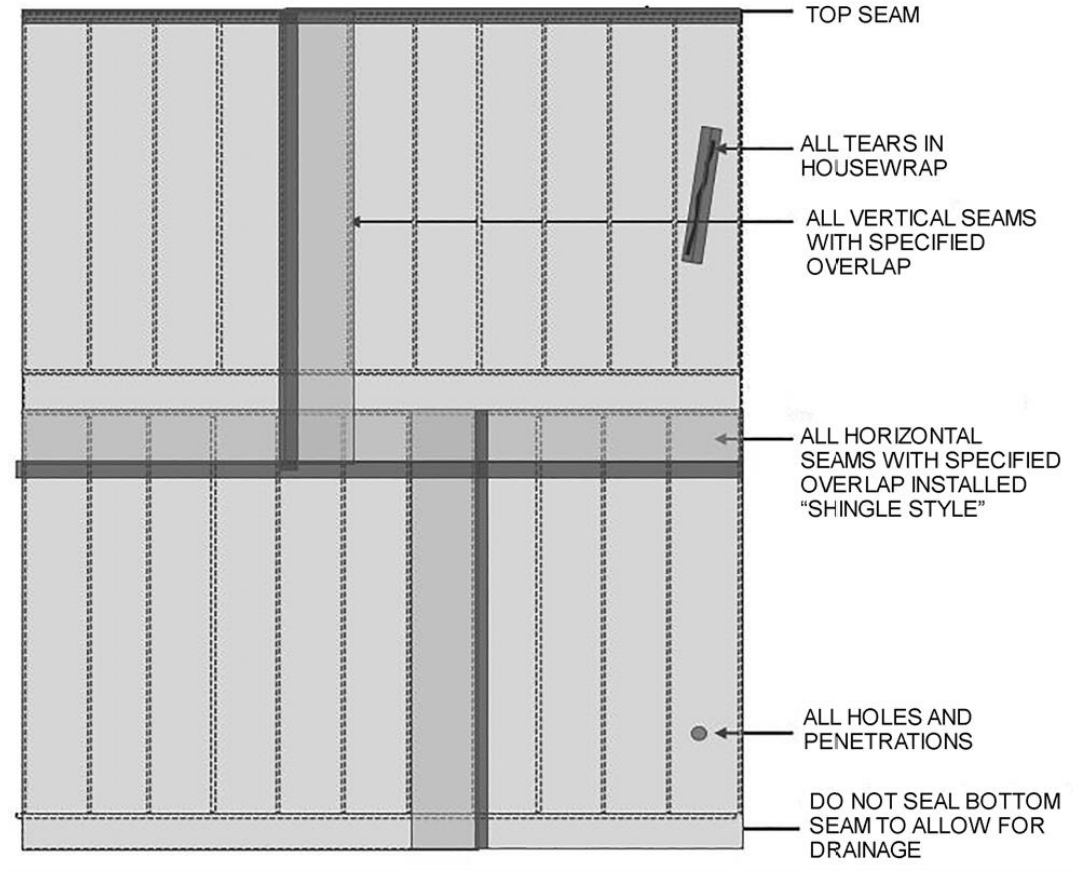
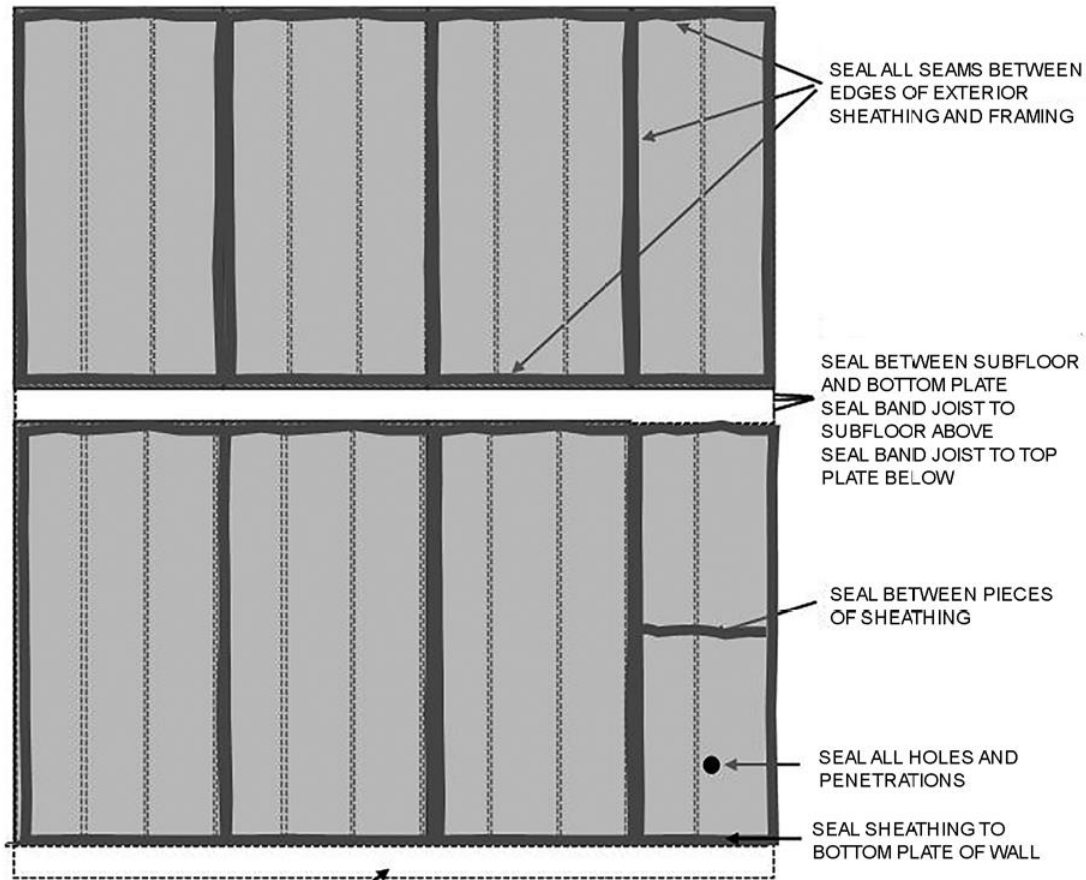
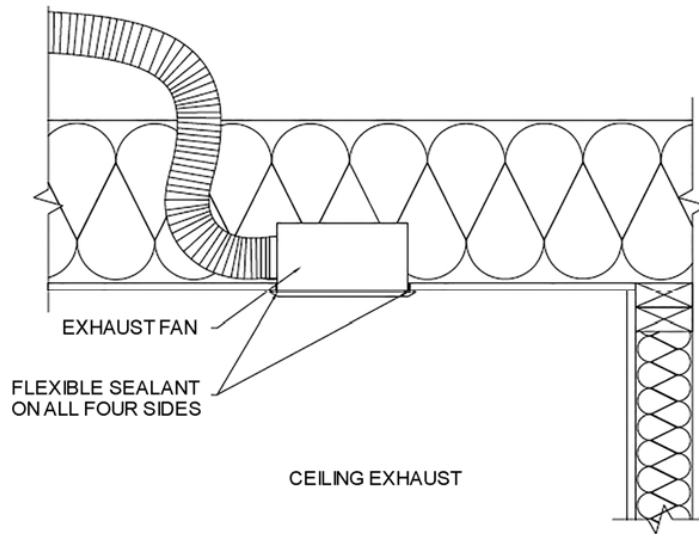

Table R402.4.1.1 Air Barrier, Air Sealing, and Insulation Installation – General requirements – sealed sheathing option



- 1) IF FIRST FLOOR IS SLAB-ON-GRADE, INSTALL SEAL SEALER UNDER BOTTOM PLATE OF EXTERIOR WALL.
- 2) IF FIRST FLOOR IS OVER UNCONDITIONED CRAWL SPACE OR BASEMENT, INSTALL SEAL SEALER UNDER BOTTOM PLATE AND SEAL SUBFLOOR TO BAND JOIST.
- 3) IF FIRST FLOOR IS OVER CONDITIONED BASEMENT OR CLOSED CRAWL SPACE WITH CRAWL SPACE WALL INSULATION BELOW, SEAL BETWEEN SUBFLOOR AND BOTTOM PLATE, SEAL BAND JOIST TO SUBFLOOR ABOVE, AND SEAL BAND JOIST TO TOP PLATE BELOW.

Table R402.4.1.1 Air Barrier, Air Sealing, and Insulation Installation – Plumbing, wiring, or other obstructions – Exhaust fan



SECTION VIEW OF SEALING EXHAUST FAN BOXES

R402.4.6 Electrical and communication outlet boxes – field-sealed

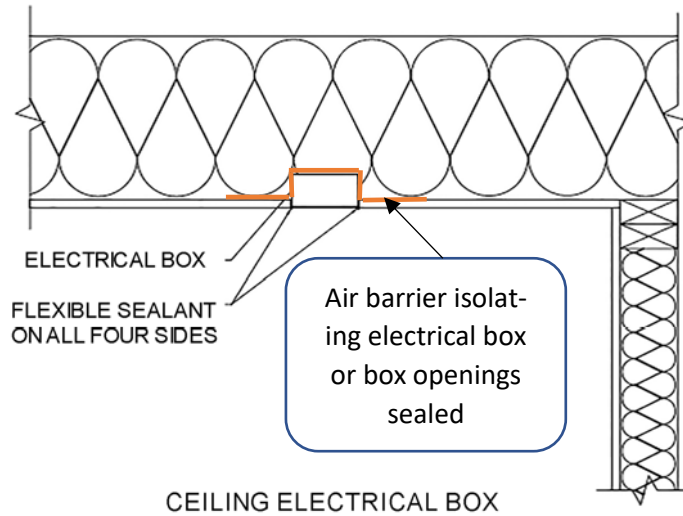

R402.4.6 Electrical and communication outlet boxes – NEMA OS 4

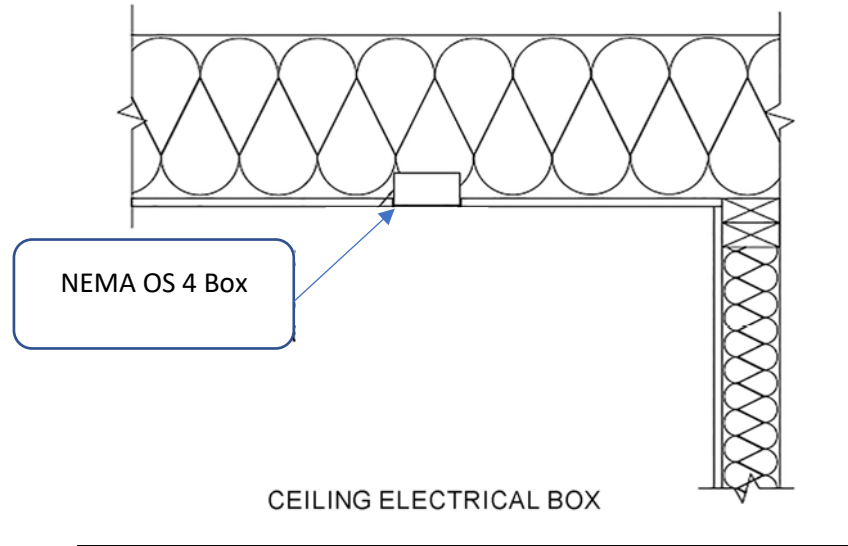

APPENDIX R2
FOAM PLASTIC DIAGRAMS
(Sections R402.2.9 and R402.2.10)

R402.2.9 Basement walls. Insulation illustrations (Includes detailing from Section R402.2.10)

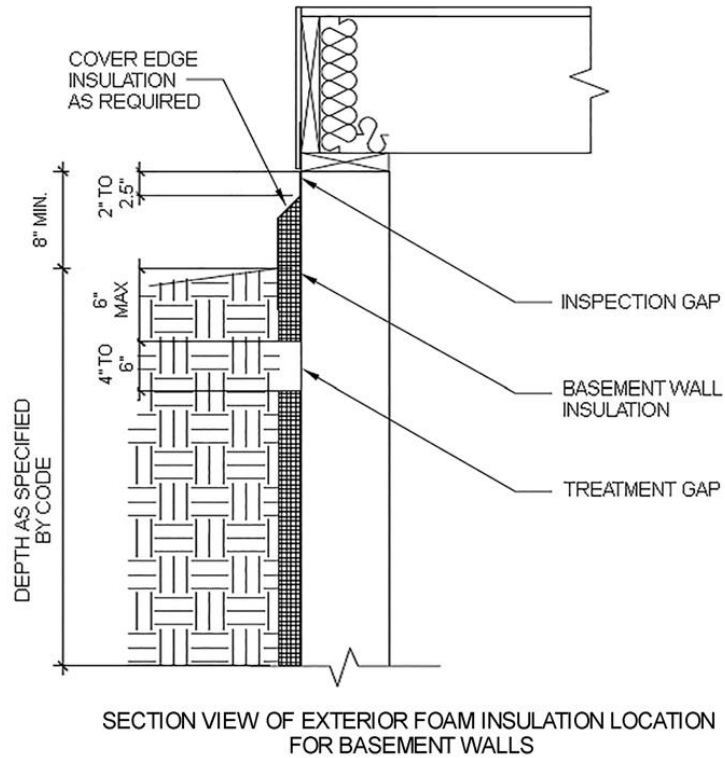

R402.2.9.1 Slab-on-grade floors. Insulation illustrations

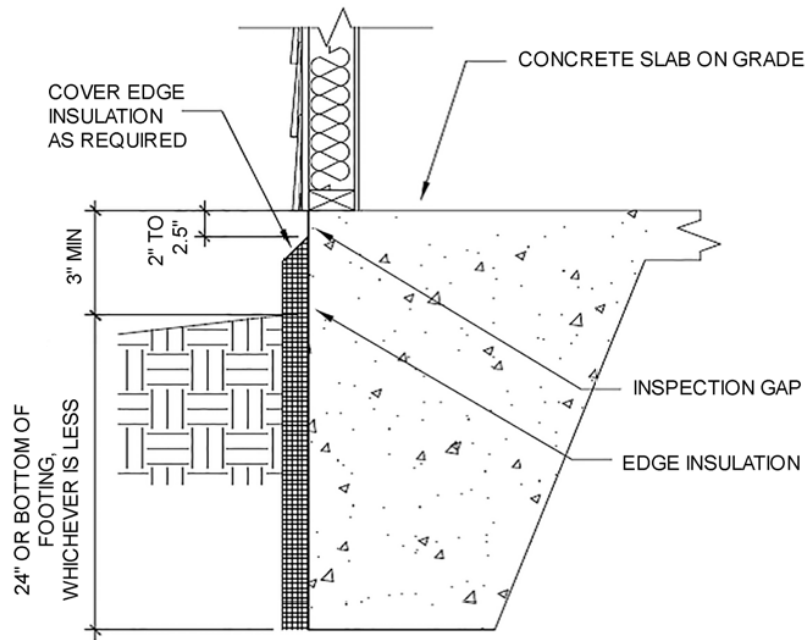

SECTION VIEW OF EDGE INSULATION FOR MONOLITHIC SLAB-ON-GRADE FLOORS

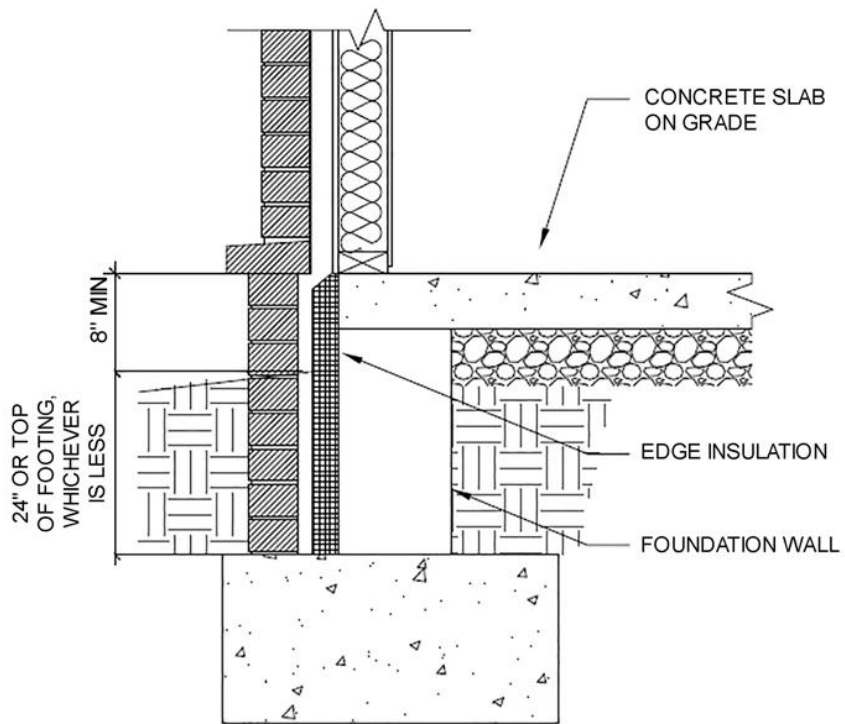

EXAMPLE FOR SLAB EDGE INSULATION LOCATION BEHIND BRICK, STONE, OR MASONRY FACING

R402.2.9.1 Slab-on-grade floors. Insulation illustrations – Floating Slab with Stem Wall

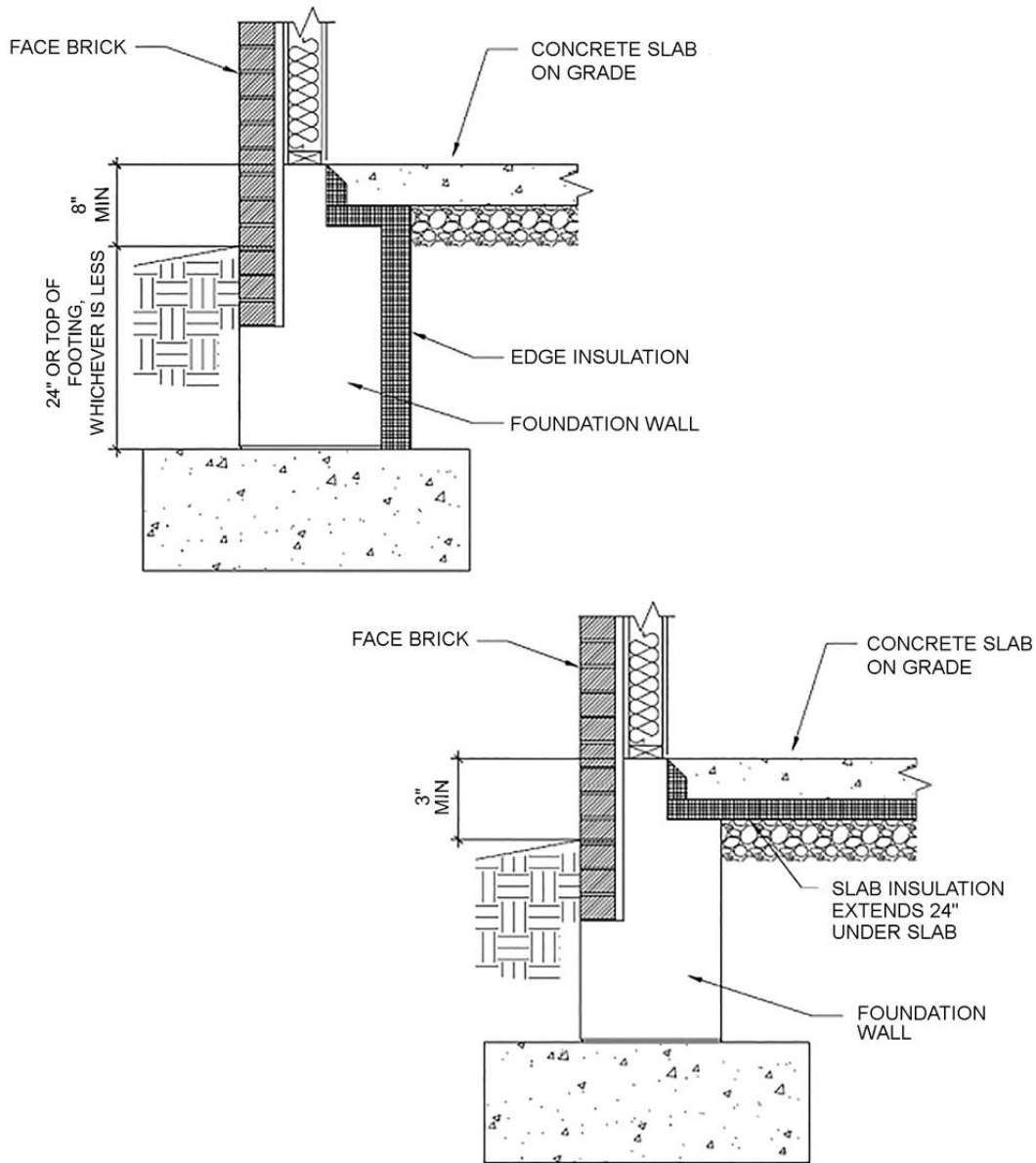

EXAMPLES FOR SLAB INSULATION LOCATION
FOR FLOATING SLAB WITH STEM WALL
(Options for brick facing are shown)

APPENDIX R3
SAMPLE WORKSHEETS FOR RESIDENTIAL AIR
AND DUCT LEAKAGE TESTING

APPENDIX R3A
Not Used

APPENDIX R3B
Air sealing: Testing (Section R402.4.1.2)
Sample Worksheet – 4.0 ACH Requirement

R402.4.1.2 Testing. The *building or dwelling unit* shall be tested for air leakage. Testing shall be conducted in accordance with ANSI/RESNET/ICC 380, ASTM E779 or ASTM E1827 and reported at a pressure of 0.2 inch w.g. (50 Pascals). If testing at a pressure of 75 Pa (0.30 in w.g.), Table Appendix R3B R402.4.1.2 shall be used for corresponding maximum allowed leakage. Where required by the *code official*, testing shall be conducted by an *approved* third party. A written report of the results of the test shall be signed by the party conducting the test and provided to the *code official*. Testing shall be performed at any time after creation of all penetrations of the *building thermal envelope* have been sealed.

- The maximum air leakage rate for any *building or dwelling unit* under any compliance path shall not exceed 4.0 air changes per hour (Test Criteria 1) or 0.23 cubic feet per minute (CFM) per square foot [0.0079 m³/(s × m²)] (Test Criteria 2) of dwelling unit enclosure area.
 - **Warning:** The 4.0 ACH threshold is a maximum for any compliance path, if following Section R401.2.1, 4.0 ACH is not allowed. See following section for requirements of R401.2.1
- When complying with Section R401.2.1, the building or dwelling unit shall have an air leakage rate not exceeding 3.0 air changes per hour in Climate Zones 3 through 5 when tested in accordance with Section R402.4.1.2. See APPENDIX R3B1 for Sample.

Table Appendix R3B R402.4.1.2 Adjustment for different test pressures

Pressure Differential (Pa)	Test pressure Adjustment Factor	Max Air Leakage / Building Thermal Envelope (CFM / ft ²)					
		0.25	0.28	0.30	0.35	0.372	0.40
75 (0.30 in. w.g.)							
50 (0.20 in. w.g.)	0.752897957	0.19	0.21	0.23	0.26	0.28	0.30

Example: If maximum air leakage allowed is 0.28 cfm/SF of bldg thermal envelope at 50 Pa(0.2 in w.g.), the corresponding maximum leakage rate is 0.372 cfm/SF of bldg thermal envelope if using a test pressure of 75 Pa(0.3 in w.g.)

Testing shall be reported by the permit holder, a North Carolina licensed general contractor, a North Carolina licensed HVAC contractor, a North Carolina licensed Home Inspector, a *registered design professional*, a certified *BPI Envelope Professional* or a certified *HERS rater*.

During testing:

1. Exterior windows and doors, fireplace and stove doors shall be closed, but not sealed;
2. Dampers shall be closed, but not sealed, including exhaust, backdraft, and flue dampers;
3. Interior doors shall be open;
4. Exterior openings for continuous ventilation systems, air intake ducted to the return side of the conditioning system, and energy or heat recovery ventilators shall be closed and sealed;
5. Heating and cooling system(s) shall be turned off; and
6. Supply and return registers shall not be sealed.

The air leakage information, building air leakage result, tester name, date, and contact information, shall be included on the certificate described in Section R401.3.

For Test Criteria 1 above, the report shall be produced in the following manner: Perform a blower door test and record the

CFM50_____. Multiply the CFM50 by 60 minutes to create CFHour50 and record _____. Then calculate the total conditioned volume of the home and record_____. Divide the CFH50 by the total volume and record the result below. If the result is less than or equal to [**4.0 ACH50**] the envelope tightness is acceptable.

For Test Criteria 2 above, the report shall be produced in the following manner: Perform the blower door test and record the CFM50_____. Calculate the total square feet of surface area for the building thermal envelope (all floors, ceilings, and walls including windows and doors, bounding conditioned space) and record the area_____. Divide CFM50 by the total square feet and record the result below. If the result is less than or equal to [**0.23 CFM50/SFSA**] the envelope tightness is acceptable.

Property Address: _____

Fan attachment location _____ Company Name _____

Contact Information: _____

Signature of Tester _____ Date _____

Permit Holder, NC Licensed General Contractor, NC Licensed HVAC Contractor, NC Licensed Home Inspector,
Registered Design Professional, Certified BPI Envelope Professional, or Certified HERS Rater
(circle one)

APPENDIX R3B1
Air sealing: Testing (Section R402.4.1.2)
Sample Worksheet – 3.0 ACH Requirement

R402.4.1.2 Testing. The *building or dwelling unit* shall be tested for air leakage. Testing shall be conducted in accordance with ANSI/RESNET/ICC 380, ASTM E779 or ASTM E1827 and reported at a pressure of 0.2 inch w.g. (50 Pascals). Where required by the *code official*, testing shall be conducted by an *approved* third party. A written report of the results of the test shall be signed by the party conducting the test and provided to the *code official*. Testing shall be performed at any time after creation of all penetrations of the *building thermal envelope* have been sealed.

- Notice: When complying with Section R401.2.1, the building or dwelling unit shall have an air leakage rate not exceeding 3.0 air changes per hour in Climate Zones 3 through 5 when tested in accordance with Section R402.4.1.2.

Testing shall be reported by the permit holder, a North Carolina licensed general contractor, a North Carolina licensed HVAC contractor, a North Carolina licensed Home Inspector, a *registered design professional*, a certified *BPI Envelope Professional* or a certified *HERS rater*.

During testing:

1. Exterior windows and doors, fireplace and stove doors shall be closed, but not sealed;
2. Dampers shall be closed, but not sealed, including exhaust, backdraft, and flue dampers;
3. Interior doors shall be open;
4. Exterior openings for continuous ventilation systems, air intake ducted to the return side of the conditioning system, and energy or heat recovery ventilators shall be closed and sealed;
5. Heating and cooling system(s) shall be turned off; and
6. Supply and return registers shall not be sealed.

The air leakage information, building air leakage result, tester name, date, and contact information, shall be included on the certificate described in Section R401.3.

The report shall be produced in the following manner: Perform a blower door test and record the *CFM50* _____. Multiply the *CFM50* by 60 minutes to create *CFHour50* and record _____. Then calculate the total conditioned volume of the home and record _____. Divide the *CFHour50* by the total volume and record the result below. If the result is less than or equal to [**3.0 ACH50**] the envelope tightness is acceptable.

Property Address: _____

Fan attachment location _____ Company Name _____

Contact Information: _____

Signature of Tester _____ Date _____

Permit Holder, NC Licensed General Contractor, NC Licensed HVAC Contractor, NC Licensed Home Inspector,
Registered Design Professional, Certified BPI Envelope Professional, or Certified HERS Rater
(circle one)

APPENDIX R3C
Duct sealing. Duct air leakage test (Sections R403.3.2, Section R403.3.3)
Sample Worksheet

R403.3.4 Sealing. Ducts, air handlers, filter boxes, and building cavities used as ducts shall be sealed. Joints and seams shall comply with either the *International Mechanical Code* or *International Residential Code*, as applicable.

Exception: Air-impermeable spray foam products shall be permitted to be applied without additional joint seals.

R403.3.5 Duct testing. Ducts shall be pressure tested in accordance with ANSI/RESNET/ICC 380 or ASTM E1554 to determine air leakage by one of the following methods:

1. Rough-in test: Total leakage shall be measured with a pressure differential of 0.1 inch w.g. (25 Pa) across the system, including the manufacturer's air handler enclosure if installed at the time of the test. Registers shall be taped or otherwise sealed during the test.
2. Postconstruction test: Total leakage shall be measured with a pressure differential of 0.1 inch w.g. (25 Pa) across the entire system, including the manufacturer's air handler enclosure. Registers shall be taped or otherwise sealed during the test.

Exception: A duct air-leakage test shall not be required for ducts serving heating, cooling or ventilation systems that are not integrated with ducts serving heating or cooling systems.

R403.3.6 Duct leakage. The total leakage of the ducts, where measured in accordance with Section R403.3.5, shall be as follows:

1. Rough-in test: The total leakage shall be less than or equal to 4.0 cubic feet per minute (113.3 L/min) per 100 square feet (9.29 m²) of *conditioned floor area* where the air handler is installed at the time of the test. Where the air handler is not installed at the time of the test, the total leakage shall be less than or equal to 3.0 cubic feet per minute (85 L/min) per 100 square feet (9.29 m²) of *conditioned floor area*.
2. Postconstruction test: Total leakage shall be less than or equal to 4.0 cubic feet per minute (113.3 L/min) per 100 square feet (9.29 m²) of *conditioned floor area*.
3. Test for ducts within thermal envelope: Where all ducts and air handlers are located entirely within the *building thermal envelope*, total leakage shall be less than or equal to 8.0 cubic feet per minute (226.6 L/min) per 100 square feet (9.29 m²) of *conditioned floor area*.

During testing:

1. Block, if present, ventilation air duct(s) connected to the conditioning system.
2. The duct air leakage testing equipment shall be attached to the largest return in the system or to the air handler.
3. The filter shall be removed and the air handler power shall be turned off.
4. Supply boots or registers and return boxes or grilles shall be taped, plugged, or otherwise sealed air tight.
5. The hose for measuring the 25 Pascals of pressure differential shall be inserted into the boot of the supply that is nominally closest to the air handler.
6. Specific instructions from the duct testing equipment manufacturer shall be followed to reach duct test pressure and measure duct air leakage.

Testing shall be performed and reported by the permit holder, a North Carolina licensed general contractor, a North Carolina licensed HVAC contractor, a North Carolina licensed home inspector, a *registered design professional*, a certified *BPI Envelope Professional* or a certified *HERS rater*. A single point depressurization, not temperature corrected, test is sufficient to comply with this provision, provided that the duct testing fan assembly(s) has been certified by the manufacturer to be capable of conducting tests in accordance with ASTM E1554-E2013.

The duct leakage information, including duct leakage test selected and result, tester name, date, and contact information, shall be included on the certificate described in Section 401.3.

For the Test Criteria, the report shall be produced in the following manner: perform the HVAC system air leakage test and record the CFM25. Calculate the total square feet of Conditioned Floor Area (CFA) served by that system.

- (1) Rough-in test: The total leakage shall be less than or equal to 4.0 cubic feet per minute (113.3 L/min) per 100 square feet (9.29 m²) of *conditioned floor area* where the air handler is installed at the time of the test. Where the air handler is not installed at the time of the test, the total leakage shall be less than or equal to 3.0 cubic feet per minute (85 L/min) per 100 square feet (9.29 m²) of *conditioned floor area*. Multiply CFM25 by 100, divide the result by the CFA and record the result. If the result is less than or equal to 3.0 CFM25/100SF (without airhandler, 4.0 with air handler) for the Total duct leakage test, then the HVAC system air tightness is acceptable.
- (2) Postconstruction test: Multiply CFM25 by 100, divide the result by the CFA and record the result. If the result is less than or equal to 5 CFM25/100SF for the Total duct leakage test, then the HVAC system air tightness is acceptable.
- (3) Test for ducts within thermal envelope: Where all ducts and air handlers are located entirely within the *building thermal envelope*, total leakage shall be less than or equal to 8.0 cubic feet per minute (226.6 L/min) per 100 square feet (9.29 m²) of *conditioned floor area*. Multiply CFM25 by 100, divide the result by the CFA and record the result. If the result is less than or equal to 8.0 CFM25/100SF for the Total duct leakage test, then the HVAC system air tightness is acceptable.

Complete one duct leakage report for each HVAC system serving the home:

Property Address: _____

Test Performed: (1) Rough-in test, (2) Postconstruction test, (3) Ducts within thermal envelope test (**circle one**)

HVAC System Number: _____ Describe area of home served: _____

CFM25 Total _____. Conditioned Floor Area (CFA) served by system: _____ s.f.

CFM25 x 100 divided by CFA = ____ CFM25/100SF (e.g. 100 CFM25 · 100/ 2,000 CFA = 5 CFM25/100SF)

Fan attachment location _____

Company Name _____

Contact Information: _____

Signature of Tester

Date

Permit Holder, NC Licensed General Contractor, NC Licensed HVAC Contractor, NC Licensed Home Inspector,
Registered Design Professional, Certified BPI Envelope Professional, or Certified HERS Rater
(circle one)

APPENDIX R4

**ADDITIONAL VOLUNTARY CRITERIA
FOR INCREASING ENERGY EFFICIENCY
(High-Efficiency Residential Option)**

Table R4C

Not used

Sample Confirmation Form for ADDITIONAL VOLUNTARY CRITERIA FOR INCREASING ENERGY EFFICIENCY (High-Efficiency Residential Option)

Not Used

-

R4D:
SAMPLE WORKSHEETS FOR RESIDENTIAL AIR AND DUCT LEAKAGE TESTING

R4D.1

Air sealing: Testing (Section R402.4.2.2)

Sample Worksheet for Alternative Residential Energy Code for Higher Efficiency

Air sealing. Building envelope air tightness shall be demonstrated by Section R402.4.2.2:

Air sealing: Testing (Section R402.4.2.2)

Sample Worksheet for Alternative Residential Energy Code for Higher Efficiency

Not used.

APPENDIX RA

BOARD OF APPEALS—RESIDENTIAL

Deleted

The provisions contained in this appendix are not mandatory unless specifically referenced in the adopting ordinance.

User note:

—**About this appendix:** Appendix RA provides criteria for board-of-appeals members. Also provided are procedures by which the board-of-appeals should conduct its business.

SECTION RA101

GENERAL

RA101.1 Scope. A board of appeals shall be established within the jurisdiction for the purpose of hearing applications for modification of the requirements of this code pursuant to the provisions of Section R110. The board shall be established and operated in accordance with this section, and shall be authorized to hear evidence from appellants and the code official pertaining to the application and intent of this code for the purpose of issuing orders pursuant to these provisions.

RA101.2 Application for appeal. Any person shall have the right to appeal a decision of the code official to the board. An application for appeal shall be based on a claim that the intent of this code or the rules legally adopted hereunder have been incorrectly interpreted, the provisions of this code do not fully apply or an equally good or better form of construction is proposed. The application shall be filed on a form obtained from the code official within 20 days after the notice was served.

RA101.2.1 Limitation of authority. The board shall not have authority to waive requirements of this code or interpret the administration of this code.

RA101.2.2 Stays of enforcement. Appeals of notice and orders, other than Imminent Danger notices, shall stay the enforcement of the notice and order until the appeal is heard by the board.

RA101.3 Membership of board. The board shall consist of five voting members appointed by the chief appointing authority of the jurisdiction. Each member shall serve for [INSERT NUMBER OF YEARS] years or until a successor has been appointed. The board members' terms shall be staggered at intervals, so as to provide continuity. The code official shall be an ex officio member of said board but shall not vote on any matter before the board.

RA101.3.1 Qualifications. The board shall consist of five individuals, who are qualified by experience and training to pass on matters pertaining to building construction and are not employees of the jurisdiction.

RA101.3.2 Alternate members. The chief appointing authority is authorized to appoint two alternate members who shall be called by the board chairperson to hear appeals during the absence or disqualification of a member. Alternate members shall possess the qualifications required for board membership, and shall be appointed for the same term or until a successor has been appointed.

RA101.3.3 Vacancies. Vacancies shall be filled for an unexpired term in the same manner in which original appointments are required to be made.

RA101.3.4 Chairperson. The board shall annually select one of its members to serve as chairperson.

RA101.3.5 Secretary. The chief appointing authority shall designate a qualified clerk to serve as secretary to the board. The secretary shall file a detailed record of all proceedings, which shall set forth the reasons for the board's decision, the vote of each member, the absence of a member and any failure of a member to vote.

RA101.3.6 Conflict of interest. A member with any personal, professional or financial interest in a matter before the board shall declare such interest and refrain from participating in discussions, deliberations and voting on such matters.

RA101.3.7 Compensation of members. Compensation of members shall be determined by law.

RA101.3.8 Removal from the board. A member shall be removed from the board prior to the end of their term only for cause. Any member with continued absence from regular meeting of the board may be removed at the discretion of the chief appointing authority.

RA101.4 Rules and procedures. ~~The board shall establish policies and procedures necessary to carry out its duties consistent with the provisions of this code and applicable state law. The procedures shall not require compliance with strict rules of evidence, but shall mandate that only relevant information be presented.~~

RA101.5 Notice of meeting. ~~The board shall meet upon notice from the chairperson, within 10 days of the filing of an appeal or at stated periodic intervals.~~

RA101.5.1 Open hearing. ~~All hearings before the board shall be open to the public. The appellant, the appellant's representative, the code official and any person whose interests are affected shall be given an opportunity to be heard.~~

RA101.5.2 Quorum. ~~Three members of the board shall constitute a quorum.~~

RA101.5.3 Postponed hearing. ~~When five members are not present to hear an appeal, either the appellant or the appellant's representative shall have the right to request a postponement of the hearing.~~

RA101.6 Legal counsel. ~~The jurisdiction shall furnish legal counsel to the board to provide members with general legal advice concerning matters before them for consideration. Members shall be represented by legal counsel at the jurisdiction's expense in all matters arising from service within the scope of their duties.~~

RA101.7 Board decision. ~~The board shall only modify or reverse the decision of the code official by a concurring vote of three or more members.~~

RA101.7.1 Resolution. ~~The decision of the board shall be by resolution. Every decision shall be promptly filed in writing in the office of the code official within 3 days and shall be open to the public for inspection. A certified copy shall be furnished to the appellant or the appellant's representative and to the code official.~~

RA101.7.2 Administration. ~~The code official shall take immediate action in accordance with the decision of the board.~~

RA101.8 Court review. ~~Any person, whether or not a previous party of the appeal, shall have the right to apply to the appropriate court for a writ of certiorari to correct errors of law. Application for review shall be made in the manner and time required by law following the filing of the decision in the office of the chief administrative officer.~~

APPENDIX RB
SOLAR-READY PROVISIONS—DETACHED ONE- AND TWO-FAMILY DWELLINGS AND TOWNHOUSES

The provisions contained in this appendix are not mandatory. ~~unless specifically referenced in the adopting ordinance.~~

User note:

~~— **About this appendix:** Harnessing the heat or radiation from the sun's rays is a method to reduce the energy consumption of a building. Although Appendix RB does not require solar systems to be installed for a building, it does require the space(s) for installing such systems, providing pathways for connections and requiring adequate structural capacity of roof systems to support the systems.~~

SECTION RB101
SCOPE

SECTION RB102
GENERAL DEFINITION

SECTION RB103
SOLAR-READY ZONE

APPENDIX RC - Reserved

~~ZERO ENERGY RESIDENTIAL BUILDING PROVISIONS~~

~~The provisions contained in this appendix are not mandatory, *unless specifically referenced in the adopting ordinance.*~~

User Note:

~~**About this appendix:** This appendix provides requirements for residential buildings intended to result in net zero energy consumption over the course of a year. Where adopted by ordinance as a requirement, Section RC101 language is intended to replace Section R401.2.~~

~~SECTION RC101 COMPLIANCE~~

~~**RC101.1 Compliance.** Existing residential buildings shall comply with Chapter 5. New residential buildings shall comply with Section RC102.~~

~~SECTION RC102 ZERO ENERGY RESIDENTIAL BUILDINGS~~

~~**RC102.1 General.** New residential buildings shall comply with Section RC102.2.~~

~~**RC102.2 Energy Rating Index zero energy score.** Compliance with this section requires that the rated design be shown to have a score less than or equal to the values in Table RC102.2 when compared to the Energy Rating Index (ERI) reference design determined in accordance with RESNET/ICC 301 for both of the following:~~

- ~~1. ERI value not including on-site power production (OPP) calculated in accordance with RESNET/ICC 301.~~
- ~~2. ERI value including on-site power production calculated in accordance with RESNET/ICC 301 with the OPP in Equation 4.1.2 of RESNET/ICC 301 adjusted in accordance with Equation RC 1.~~

~~Adjusted OPP = OPP + CREF + REPC (Equation PX-1)~~

~~where:~~

~~CREF = Community Renewable Energy Facility power production—the yearly energy, in kilowatt hour equivalent (kWh_{eq}), contracted from a community renewable energy facility that is qualified under applicable state and local utility statutes and rules, and that allocates bill credits to the rated home.~~

~~REPC = Renewable Energy Purchase Contract power production—the yearly energy, in kilowatt hour equivalent (kWh_{eq}), contracted from an energy facility that generates energy with photovoltaic, solar thermal, geothermal energy or wind systems, and that is demonstrated by an energy purchase contract or lease with a duration of not less than 15 years.~~

~~TABLE RC102.2~~

~~MAXIMUM ENERGY RATING INDEX^a~~

CLIMATE ZONE	ENERGY RATING INDEX NOT INCLUDING OPP	ENERGY RATING INDEX INCLUDING ADJUSTED OPP (as proposed)
1	43	0
2	45	0
3	47	0
4	47	0
5	47	0

6	46	0
7	46	0
8	46	0

~~a. The building shall meet the requirements of Table R406.2, and the building thermal envelope shall be greater than or equal to the levels of efficiency and SHGC in Table R402.1.2 or R402.1.3.~~

INDEX